



# Oxygen therapy for children



World Health  
Organization



# Oxygen therapy for children



World Health  
Organization

WHO Library Cataloguing-in-Publication Data

Oxygen therapy for children: a manual for health workers.

1.Anoxia – prevention and control. 2.Oxygen Inhalation Therapy. 3.Child; Hospitalized. 4.Pneumonia – complications. 5.Handbooks. I.World Health Organization.

ISBN 978 92 4 154955 4

(NLM classification: WS 29)

**© World Health Organization 2016**

All rights reserved. Publications of the World Health Organization are available on the WHO website (<http://www.who.int>) or can be purchased from WHO Press, World Health Organization, 20 Avenue Appia, 1211 Geneva 27, Switzerland (tel.: +41 22 791 3264; fax: +41 22 791 4857; email: [bookorders@who.int](mailto:bookorders@who.int)).

Requests for permission to reproduce or translate WHO publications – whether for sale or for non-commercial distribution – should be addressed to WHO Press through the WHO website ([http://www.who.int/about/licensing/copyright\\_form/index.html](http://www.who.int/about/licensing/copyright_form/index.html)).

The designations employed and the presentation of the material in this publication do not imply the expression of any opinion whatsoever on the part of the World Health Organization concerning the legal status of any country, territory, city or area or of its authorities, or concerning the delimitation of its frontiers or boundaries. Dotted and dashed lines on maps represent approximate border lines for which there may not yet be full agreement.

The mention of specific companies or of certain manufacturers' products does not imply that they are endorsed or recommended by the World Health Organization in preference to others of a similar nature that are not mentioned. Errors and omissions excepted, the names of proprietary products are distinguished by initial capital letters.

All reasonable precautions have been taken by the World Health Organization to verify the information contained in this publication. However, the published material is being distributed without warranty of any kind, either expressed or implied. The responsibility for the interpretation and use of the material lies with the reader. In no event shall the World Health Organization be liable for damages arising from its use.

Printed by the WHO Document Production Services, Geneva, Switzerland

---

# Contents

Acronyms and abbreviations	v
Acknowledgements	vi
<b>1. Introduction</b>	<b>1</b>
1.1 Background	1
1.2 Purpose of the manual	2
1.3 Target audience	2
1.4 Development process	2
1.5 Financial support	3
<b>2. Hypoxaemia and hypoxia</b>	<b>4</b>
2.1 Definitions	4
2.2 Causes in neonates	7
2.3 Causes in children	7
2.3.1 Acute respiratory infections	8
2.3.2 Other conditions	9
<b>3. Detection of hypoxaemia</b>	<b>9</b>
3.1 Clinical signs	10
3.1.1 In neonates	10
3.1.2 In children	11
3.2 Pulse oximetry	14
3.2.1 Clinical use	14
3.2.2 Features	14
3.3 Gas analysis of blood	18
<b>4. Sources and delivery of oxygen</b>	<b>21</b>
4.1 Sources	21
4.2 Methods of delivery	22
4.2.1 Neonates	29
4.2.2 Children	30
<b>5. Continuous positive airway pressure</b>	<b>34</b>
5.1 Bubble CPAP	34
5.2 Humidified high flow through nasal prongs	37

---

<b>6. Humidification</b>	<b>39</b>
6.1 Rationale	39
6.2 Unheated bubble humidifiers	39
6.3 Safety of humidifiers	40
6.4 During tracheostomy	41
<b>7. Monitoring the progress of children on oxygen</b>	<b>42</b>
7.1 When to stop oxygen	43
7.2 General care of children with hypoxaemia or severe respiratory distress	44
<b>References</b>	<b>46</b>
Annex 1. Practical use of pulse oximetry in children's wards	51
Annex 2. Administration of oxygen with oxygen concentrators	53
Annex 3. Administration of oxygen from oxygen cylinders	56

---

# Acronyms and abbreviations

CPAP	continuous positive airway pressure
F	French (measure of catheter diameter)
FiO <sub>2</sub>	fraction of inspired oxygen
PaO <sub>2</sub>	partial oxygen pressure
PEEP	positive end expiratory pressure
SaO <sub>2</sub>	arterial haemoglobin oxygen saturation as measured by blood gas analysis
SpO <sub>2</sub>	arterial haemoglobin oxygen saturation as measured by pulse oximetry

---

# Acknowledgements

We are grateful to the main editor, Professor Trevor Duke, at the Centre for International Child Health, University of Melbourne, Department of Paediatrics, The Royal Children's Hospital, Victoria, Australia.

We are also grateful to the following people who contributed substantially to preparation of this manual: Olivier Fontaine (France); Susanne Carai (Germany); David Peel, Harry Campbell and Iain Wilson (United Kingdom); Bernhard Frey (Switzerland); Penny Enarson (France); Mike English (Kenya); and Bob Jacobson, Kathy Sanchez and Ravi Bansal (USA).

We thank the following people who reviewed the manual or contributed to topics: Sens Matai, Francis Wandu and Marilyn Jonathan (Papua New Guinea); Sophie La Vincente, Rami Subhi, Dave Tickell, Eleanor Neal and Amy Auge (Australia); Steve Howie (New Zealand); Grace Irimu (Kenya); Sandro Contini (Italy); Mike Dobson and Brigid Hayden (United Kingdom); and KA Kelly McQueen and Hilary Cohen (USA).

We are grateful to the following WHO staff who provided technical input during preparation of the manual: Rajiv Bahl, Martin Weber, Meena Cherian and Samira Aboubaker.

The publication was coordinated by Wilson Were and Shamim Qazi of the Department of Maternal, Newborn, Child and Adolescent Health.

We also thank David Woodroffe of David Woodroffe Digital Illustration, for preparing the illustrations.



---

# 1. Introduction

## 1.1 Background

Every year, over 5.9 million children die, mostly from preventable or easily treatable diseases, and more than 95% of those deaths occur in developing countries. Pneumonia is the leading cause of death in children under 5 years of age, being responsible for at least 18% of all deaths in this age category (1).

In 2010, there were an estimated 120 million episodes of pneumonia in children under 5 years, of which 14 million progressed to severe disease and 1.3 million led to death (2). Hypoxaemia (insufficient oxygen in the blood) is the major fatal complication of pneumonia, increasing the risk for death many times. It is estimated that at least 13.3% of children with pneumonia have hypoxaemia (3), corresponding to 1.86 million cases of hypoxaemic pneumonia each year.

A further 23% of the 5.9 million annual child deaths result from neonatal conditions such as birth asphyxia, sepsis and low birth weight, all of which can lead to hypoxaemia. These add to the substantial burden of hypoxaemia, especially in developing countries.

Despite its importance in virtually all types of acute severe illness, hypoxaemia is often not well recognized or managed in settings where resources are limited. Oxygen treatment remains an inaccessible luxury for a large proportion of severely ill children admitted to hospitals in developing countries. This is particularly true for patients in small district hospitals, where, even if some facility for delivering oxygen is available, supplies are often unreliable and the benefits of treatment may be diminished by poorly maintained, inappropriate equipment, poorly trained staff or inadequate guidelines.

Increasing awareness of these problems is likely to have considerable benefits for clinical and public health. Health workers should know the clinical signs that suggest the presence of hypoxaemia. More reliable detection of hypoxaemia could be achieved through more widespread use of pulse oximetry, which is a non-invasive measure of arterial oxygen saturation. Oxygen therapy must be more widely available; in many remote settings, this can be achieved by use of oxygen concentrators, which can run on regular or alternative sources of power.

Several conditions must be met for hypoxaemic children to receive appropriate, uninterrupted oxygen therapy for as long as is necessary to save their lives. First, a child must be recognized as hypoxaemic, either by a trained health care provider on the basis of clinical signs or with a pulse oximeter. Then, the child recognized as hypoxaemic must receive adequate, uninterrupted oxygen therapy for an adequate duration.

Many developing countries have growing experience in the clinical, organizational, biomedical technology and training aspects of setting up and sustaining effective oxygen delivery systems in hospitals and small health facilities. There is strong evidence that use of pulse oximetry and the availability of reliable oxygen sources in district and provincial hospitals can reduce death rates from pneumonia by about one third (4).

This manual focuses on the clinical aspects of oxygen therapy in children in health facilities. We hope that it will stimulate efforts to improve oxygen systems worldwide by describing practical aspects for health staff, biomedical engineers, administrators and health officers.

## 1.2 Purpose of the manual

The manual is part of a series of resources for improving the quality of care for severely ill children in health facilities. It supports the improved use and availability of oxygen therapy in low resource settings. The manual addresses the need for appropriate detection of hypoxaemia and use of pulse oximetry, oxygen delivery systems and monitoring of patients on oxygen therapy. In addition, the manual addresses practical use of pulse oximetry, and oxygen concentrators and cylinders. The main purpose is to:

- Increase the awareness and the need for improving the availability of oxygen therapy in low resource settings.
- Improve the detection and management of hypoxaemia in the severely ill children.
- Improve the delivery and monitoring of patients on oxygen therapy.

This practical bedside manual can be used in most areas of the world and can be adapted to country-specific circumstances.

## 1.3 Target audience

This manual is intended primarily for use by health care providers, policy makers, biomedical engineers, child health programme managers, health facility administrators, and other paramedical professional staff involved in the care of children. It can also be used as a resource in medical and paramedical pre-service training institutions.

## 1.4 Development process

The development process started with a desk review on the availability and use of oxygen therapy in hospitals. A consultative process with the end users and experts on the content and format of the manual was undertaken. Following this process and based on the prior advice of the Guidelines Review Committee, it was agreed to have two separate publications, a manual on the clinical use of oxygen therapy and a technical manual on specifications of oxygen sources.

As a result this manual is an update of the *Oxygen therapy for acute respiratory infections in young children in developing countries* published in 1993. (<http://www>.

---

[who.int/maternal\\_child\\_adolescent/documents/ari\\_93\\_28/en/](http://who.int/maternal_child_adolescent/documents/ari_93_28/en/)). It was updated and reorganized to provide basic information on detection and management of hypoxaemia, oxygen delivery systems and monitoring of oxygen therapy in children. It is a compilation of up-to-date recommendations on oxygen delivery and use, and where there were gaps, evidence was collated, reviewed and appropriate recommendations were made as part of the updated paediatric emergency triage assessment and treatment guidelines. All the recommendations are therefore derived from two main recent publications:

- Recommendations for management of common childhood conditions: evidence for technical update of pocket book recommendations. Geneva: World Health Organization; 2012 ([http://www.who.int/maternal\\_child\\_adolescent/documents/management\\_childhood\\_conditions/en/](http://www.who.int/maternal_child_adolescent/documents/management_childhood_conditions/en/))
- Paediatric emergency triage, assessment and treatment: care of critically-ill children: Updated guideline. Geneva: World Health Organization; 2016 ([http://who.int/maternal\\_child\\_adolescent/documents/paediatric-emergency-triage-update/en/](http://who.int/maternal_child_adolescent/documents/paediatric-emergency-triage-update/en/))

The approach to clinical management is drawn from the Pocket book of hospital care for children. Guidelines for the management of common childhood illnesses, 2nd edition. Geneva: World Health Organization; 2013 ([http://www.who.int/maternal\\_child\\_adolescent/documents/child\\_hospital\\_care/en/](http://www.who.int/maternal_child_adolescent/documents/child_hospital_care/en/)).

Technical specifications for oxygen concentrators are taken from the Technical specifications for oxygen concentrators. (WHO Medical Device Technical Series). Geneva: World Health Organization; 2015 ([http://apps.who.int/iris/bitstream/10665/199326/1/9789241509886\\_eng.pdf](http://apps.who.int/iris/bitstream/10665/199326/1/9789241509886_eng.pdf))

## 1.5 Financial support

The main source of funding to support this work was from the Bill and Melinda Gates Foundation and the Russian Federation through the quality of care improvement initiative. Additional budget support was from the WHO Collaborating Centre for International Child Health (CICH) in Melbourne, Australia.

---

## 2. Hypoxaemia and hypoxia

Reduced oxygen delivery and failure of cellular use of oxygen occur under various circumstances. If hypoxia is not recognized, it results in organ dysfunction and death.

### 2.1 Definitions

Hypoxaemia means low levels of oxygen in the blood (low blood oxygen saturation or content). Hypoxia is inadequate oxygen in tissues for normal cell and organ function, and hypoxia results from hypoxaemia. Hypoxaemia occurs frequently in diseases like lower respiratory tract infection (severe pneumonia or bronchiolitis), upper airway obstruction, severe asthma, common neonatal conditions like birth asphyxia and in respiratory distress syndrome, severe sepsis, heart failure, cardiac arrest, trauma, carbon monoxide poisoning, and obstetric and perioperative emergencies.

As all the functions of the human body require oxygen, oxygen deprivation can have severe adverse effects on the cells that perform important biological processes. Lack of oxygen leads very quickly to dysfunction of the organ systems, and death. Therefore, hypoxaemia is a life-threatening condition that requires early detection and treatment.

Arterial oxygen saturation is referred to as  $SaO_2$  when measured by gas analysis and as  $SpO_2$  when measured by pulse oximetry (for more details, see [section 2](#)). The normal range of  $SpO_2$  at sea level is 97–99%, with a lower limit (mean minus 2 standard deviations) of 94% (5). Therefore, the percentage is lower in children living at high altitude because of a lower partial oxygen pressure ( $PaO_2$ ) at higher altitude (see [Fig. 1](#) and text box below).

The amount of oxygen used varies with the threshold at which hypoxaemia is defined and oxygen is given. In one hospital, it was found that 13% of children with pneumonia were hypoxaemic at  $SpO_2 < 85\%$ , 26% at  $SpO_2 < 90\%$  and 44% at  $SpO_2 < 93\%$  (6). In practice, the threshold at which oxygen is given is often  $SpO_2 < 90\%$ , which corresponds to the flat part of the haemoglobin–oxygen dissociation curve ([Fig. 2](#)) and represents a safe margin of error where there are sufficient oxygen supplies. Small reductions in  $SpO_2$  below 90% may represent a dangerous fall in  $PaO_2$  (steep part of the curve).

Oxygen therapy at higher thresholds than 90%  $SpO_2$  are required in some conditions, such as serious impairment of oxygen delivery from the lungs to body tissues and when the vital organs are particularly susceptible to low oxygen levels. Examples include severe anaemia (in which haemoglobin may be normally saturated but provides too little oxygen because of too little haemoglobin), severe heart failure, severe sepsis or brain injury or in critically ill children with emergency signs. In these conditions, especially during the resuscitation phase, give oxygen if the  $SpO_2$  is  $< 94\%$ .

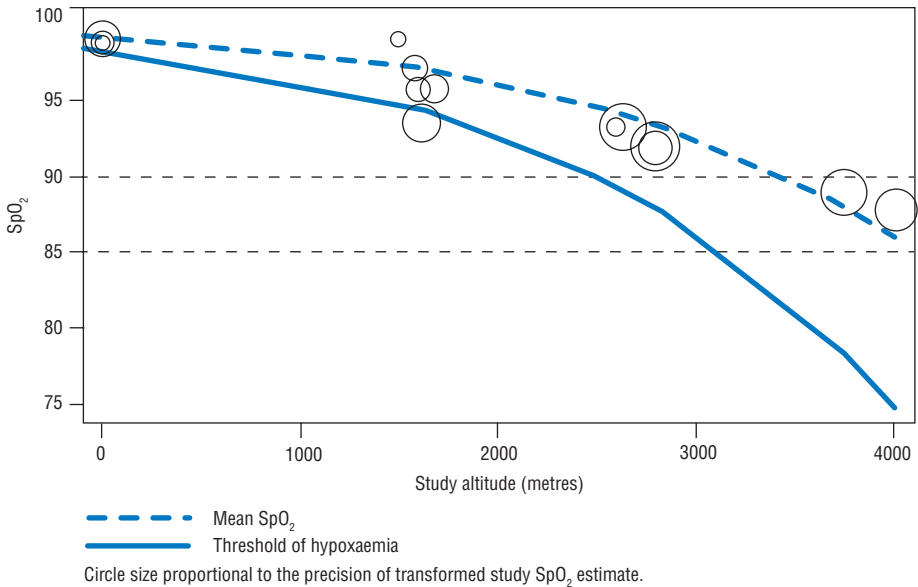
**Fig. 1. Threshold of hypoxaemia at different altitudes**

Oxygen is transported in the blood in two forms: physically dissolved in plasma (2%) and chemically bound to the haemoglobin molecule in red blood cells (98%). The amount of oxygen in the blood (sum of both forms, dissolved and bound to haemoglobin) is described in mL of O<sub>2</sub> per 100 mL blood (or volume %).

In order to determine how much oxygen is dissolved in plasma, the arterial oxygen tension or partial oxygen pressure (PaO<sub>2</sub>) is measured (in mm Hg or kPa). The PaO<sub>2</sub> is a measure only of oxygen molecules dissolved in plasma and not of those bound to haemoglobin; however, as there is a dynamic equilibrium between freely dissolved and haemoglobin-bound oxygen molecules, oxygen saturation can be calculated from the PaO<sub>2</sub>. This relation is described by the haemoglobin–oxygen dissociation curve (Fig. 2).

The “gold standard” for measuring arterial oxygen tension (PaO<sub>2</sub>) and for calculating oxygen saturation is blood gas analysis. This method is, however, invasive, painful and distressing to the patient, and blood gas machines and reagents are very expensive. Therefore, it is not appropriate in most district hospitals in developing countries.

The main carrier of oxygen in the blood is haemoglobin, and each haemoglobin molecule can carry four oxygen molecules. The oxygen content of haemoglobin is expressed as oxygen saturation (SO<sub>2</sub>), i.e. the ratio between haemoglobin carrying oxygen (oxy-haemoglobin) and total haemoglobin. When arterial haemoglobin oxygen saturation is measured by arterial blood gas analysis, it is known as SaO<sub>2</sub>, and when it is measured non-invasively by pulse oximetry (see section 2), it is known as SpO<sub>2</sub> (haemoglobin oxygen pulsed saturation). SpO<sub>2</sub>, which is related to PaO<sub>2</sub>, is therefore used to define hypoxaemia in these guidelines (see Fig. 2).

### The haemoglobin–oxygen dissociation curve

The haemoglobin-oxygen dissociation curve mathematically equates the percentage oxygen saturation of haemoglobin ( $SpO_2$  or  $SaO_2$ ) to the  $PaO_2$  in blood. The number of  $O_2$  molecules dissolved in plasma determines (with other factors) how many molecules will bind to haemoglobin. At high  $PaO_2$  (i.e. in the lungs), oxygen will bind to haemoglobin. In tissues deprived of oxygen, the  $PaO_2$  will decrease (the dissolved oxygen moves from the blood to tissues) and, consequently, the haemoglobin releases oxygen.

The tendency of haemoglobin to bind oxygen is not, however, linear. Each haemoglobin molecule can carry four oxygen molecules, and the tendency to bind oxygen molecules becomes greater after the first molecule has been bound; therefore, the dissociation curve has a sigmoid shape. As the maximum amount that can be bound is reached and the haemoglobin becomes saturated with oxygen, little additional binding occurs, and the curve levels out. Thus, at high oxygen pressure, relatively large changes in pressure lead to only small changes in oxygen saturation (flat part of the curve). Below an oxygen saturation of 90%, however, small falls in  $PaO_2$  result in much larger falls in  $SpO_2$  (steep part of the curve).

It is important to note that the dissociation of oxygen is also directly affected by changes in temperature, pH and 2,3-diphosphoglycerate.

**Fig. 2. Haemoglobin–oxygen dissociation curve**

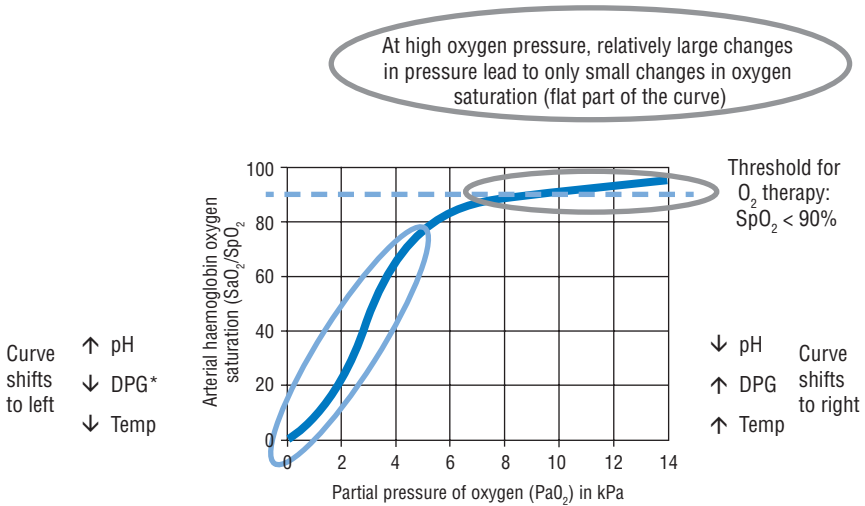

At  $SpO_2$  90% small reduction in  $SpO_2$  may result in dangerous falls in  $PaO_2$  (steep part of the curve)

\* DPG is 2,3-diphosphoglycerate

---

## 2.2 Causes in neonates

In the first hour after delivery, normal newborn infants have lower normal oxygen saturation. It may take an hour or more for oxygen saturation to reach levels above 90%. The normal level for a newborn in the first hours of life is typically 88% or more (7). Therefore, oxygen therapy should achieve this level.

A number of conditions that can lead to hypoxaemia occur only, or at higher frequency, in neonates, notably respiratory distress syndrome, birth asphyxia and transient tachypnoea of the neonate. Pneumonia is also very common (8). Neonates who are very unwell for reasons such as prematurity, sepsis, seizures or hypoglycaemia are also prone to apnoea. Apnoea and hypoventilation also occur in otherwise-well infants of very low birth weight (< 1.5 kg or gestational age < 32 weeks) because of immature respiratory drive (apnoea of prematurity). Apnoea can lead to hypoxaemia and slow the heart rate (bradycardia), further reducing oxygen delivery to tissues.

## 2.3 Causes in children

### 2.3.1 Acute respiratory infections

Hypoxaemia is a common complication in acute lower respiratory tract infections in children and is a strong risk factor for death. The most common such infections are pneumonia and bronchiolitis, which account for most cases of hypoxaemia in children in developing countries. In a systematic review of studies of more than 20 000 children with acute pneumonia or other lower respiratory tract infection, the median prevalence of hypoxaemia in children with severe and very severe pneumonia (WHO clinical classification) was 13% (9–38%) (3). Given that an estimated 14 million children each year have severe or very severe pneumonia (2), this corresponds to 1.86 million cases of hypoxaemic pneumonia annually.

The prevalence of hypoxaemia is generally higher in referral hospitals – some rates exceed 50% for children with severe pneumonia – than in primary care settings, because more severely ill children are referred. Hypoxaemia is also more common at higher altitude, in younger ages and apparently in certain geographical regions (3).

Pneumonia in children is most commonly due to bacteria (*Streptococcus pneumoniae* and *Haemophilus influenzae*) and viruses (respiratory syncytial virus, influenza virus). Other pathogens are common in certain high-risk groups, such as malnourished children, neonates and children with HIV infection, who may be infected with pathogens including *Staphylococcus aureus*, enteric Gram-negative bacilli such as *Escherichia coli* and *Klebsiella* species, *Pneumocystis jiroveci* (formerly *Pneumocystis carinii*) and *Mycobacterium tuberculosis*. Hypoxaemia can be a complication of pneumonia due to any of these common pathogens, depending on the severity and stage of presentation. Epidemics of influenza are a potential risk, and effective oxygen systems are needed in all countries for effective management of influenza epidemics.

### 2.3.2 Other conditions

Hypoxaemia also occurs in some children with other illnesses, such as acute asthma, meningitis and sepsis, but is less frequent than in acute lower respiratory tract infection. Asthma is an increasing problem globally, especially where urbanization is increasing and among middle-class populations. In one study, 13 of 51 children presenting to an emergency department in India with asthma had hypoxaemia (9). Other conditions in which hypoxaemia can occur include heart failure or cardiac arrest, anaemia, carbon monoxide poisoning, trauma and perioperative emergencies.

Even conditions that are infrequently complicated by hypoxaemia, such as malaria (3–5% of all hospitalized cases have hypoxaemia), can contribute substantially to the global burden of hypoxaemia because they are so common (3).

#### KEY MESSAGES

- Hypoxaemia is a life-threatening condition.
- Hypoxaemia occurs frequently in children with pneumonia, common neonatal conditions, trauma or perioperative emergencies.
- Hypoxaemia can be treated easily by giving oxygen.
- Arterial oxygen saturation (oxygen level in the blood) is referred to as  $\text{SaO}_2$  or  $\text{SpO}_2$ .
- The normal range of  $\text{SpO}_2$  at sea level is 94–100%.
- Children living at high altitude are used to living with lower oxygen saturation; therefore, the threshold for giving oxygen is lower at higher altitude. At high altitude, however, severe pneumonia can progress more quickly to severe hypoxaemia, so that oxygen is more likely to be required.
- In the first hour after delivery, newborn infants have lower than normal oxygen saturation. It may take an hour or more for oxygen saturation to reach  $\geq 90\%$ .



---

## 3. Detection of hypoxaemia

Clinicians can detect hypoxaemia from clinical signs, with pulse oximeters or by blood gas analysis. This section outlines these methods and explains the advantages and disadvantages of each.

Severe hypoxaemia can often be recognized by certain **clinical signs**, which are blue colouring of the tongue or gums (central cyanosis), nasal flaring, inability to drink or feed (when due to respiratory distress), grunting with every breath and depressed mental state (i.e. drowsy, lethargic). In some situations, and depending on the overall clinical condition, children with the following less specific signs may have hypoxaemia: fast breathing (respiratory rate of 70/min or more), severe lower chest wall indrawing and head nodding. These are important signs for all health workers to know, and it is essential that they can recognize generally very sick patients. However, even the best observations of clinical signs commonly result in misdiagnosis of hypoxaemia in children with normal oxygen saturation or failure to detect hypoxaemia in others.

**Pulse oximetry** is the most accurate non-invasive method for detecting hypoxaemia. It is used to measure the percentage of oxygenated haemoglobin in arterial blood ( $\text{SpO}_2$ ). The pulse oximeter consists of a computerized unit and a sensor probe, which is attached to the patient's finger, toe or earlobe. The oximeter displays the  $\text{SpO}_2$  with an audible signal for each pulse beat, a pulse rate and, in most models, a graphical display of the blood flow past the probe (the plethysmographic or pulse wave). The technology is robust and the cost quite low. Pulse oximeters can be used to both detect and monitor hypoxaemia, make more efficient use of oxygen supplies and improve patient monitoring; they are cost-effective for district hospitals (10).

**Blood gas analysis** is another very accurate method for detecting hypoxaemia. It is used to measure the partial pressure of oxygen ( $\text{PaO}_2$ ) and carbon dioxide in blood and also blood pH and the concentrations of the main electrolytes. The method has several drawbacks. Blood gas analysers are very expensive, and the chemical reagents represent a high recurrent cost, which may be unaffordable for hospitals with limited resources. Inaccurate measurements can easily result from factors such as a poorly taken sample (especially from a struggling or uncooperative child), delay in transfer of the sample to a laboratory, inadequate storage conditions before analysis and inadequate maintenance or quality control in the laboratory. The method is also invasive and uncomfortable, as it requires taking blood. Therefore, blood gas analysis is not suitable for most hospitals with limited resources.

## RECOMMENDATIONS FOR DETECTING HYPOXAEMIA

	RECOMMENDATION	QUALITY OF EVIDENCE
<b>1.</b>	<b>Use pulse oximetry to detect hypoxaemia.<sup>a</sup></b>	
	Pulse oximetry is recommended for determining the presence of hypoxaemia and for guiding administration of oxygen therapy to infants and children.	Strong recommendation ( <i>low-quality evidence</i> )
<b>2.</b>	<b>When clinical signs are used to detect hypoxaemia in children:<sup>b</sup></b>	
(a)	Use pulse oximetry whenever possible for the detection of hypoxaemia in children with severe lower respiratory tract infections. If oximetry is not available, the following clinical signs could be used to determine use of oxygen therapy: <ul style="list-style-type: none"> <li>• central cyanosis</li> <li>• nasal flaring</li> <li>• inability to drink or feed (when due to respiratory distress)</li> <li>• grunting with every breath</li> <li>• depressed mental state (i.e. drowsy, lethargic)</li> </ul>	Strong recommendation ( <i>low-quality evidence</i> )
(b)	In some situations, and depending on the overall clinical condition, children with the following less specific signs may also need oxygen: <ul style="list-style-type: none"> <li>• severe lower chest wall indrawing</li> <li>• respiratory rate <math>\geq</math> 70/min</li> <li>• head nodding</li> </ul>	Strong recommendation ( <i>very low-quality evidence</i> )

<sup>a</sup> Although no studies have been reported of the comparison of measuring arterial blood gases with pulse oximetry in children, a meta-analysis of studies in adults showed a very high correlation (77). Pulse oximetry is non-invasive, easy to do and does not require any special skills.

<sup>b</sup> Clinical signs are very unreliable for detecting hypoxaemia and should not be relied upon except when pulse oximetry is not available.

### 3.1 Clinical signs

Clinical signs are not reliable predictors of hypoxaemia, and their use alone for diagnosis can lead to false-positive or false-negative results. In many situations, however, such as in primary health facilities or triage in an outpatient or emergency department, it may not be possible to perform pulse oximetry. Different clinical signs are indicative of hypoxaemia in neonates, children and adults. It is important that health workers can identify very sick patients clinically and can identify the clinical signs of hypoxaemia, rather than relying on monitoring equipment that is not available or functions poorly.

#### 3.1.1 In neonates

The signs of hypoxaemia in neonates and young infants are not specific, sometimes resulting in delayed recognition by parents and presentation at a relatively advanced stage. Even an experienced health worker may find it difficult to detect hypoxaemia.

As in older infants and children (see next section), no one clinical sign can be used to identify all hypoxaemic neonates. Several studies have shown that, in neonates, as in infants and children, fast breathing is both insensitive (i.e. many children with hypoxaemia may not have fast breathing) and nonspecific (i.e. many children with fast breathing are not hypoxaemic) for detecting hypoxaemia. As in older children, cyanosis is the most specific clinical sign, but more than one fourth of neonates with hypoxaemia are not identified as cyanosed.

These considerations argue strongly for the use of pulse oximetry in the management of sick neonates and the importance of teaching health workers to screen for these common clinical signs. Monitoring of apnoea is also recommended for in-patient monitoring of very low-birth-weight infants and premature neonates, when available.

### 3.1.2 In children

This section describes the clinical signs that suggest hypoxaemia in children. The precision of clinical signs for predicting hypoxaemia has been reviewed (12, 13).

#### Central cyanosis

Oxygenated haemoglobin is red, while deoxygenated haemoglobin is blue. If the red cells in the blood are not fully loaded with oxygen, the skin and mucous membranes appear blue. This is known as central cyanosis (see Fig. 3).

**Fig. 3. Child with central cyanosis and chest indrawing**

The monitor shows that the  $SpO_2$  is 66% and the pulse wave trace is good, confirming the presence of severe hypoxaemia. The infant should be given oxygen urgently.

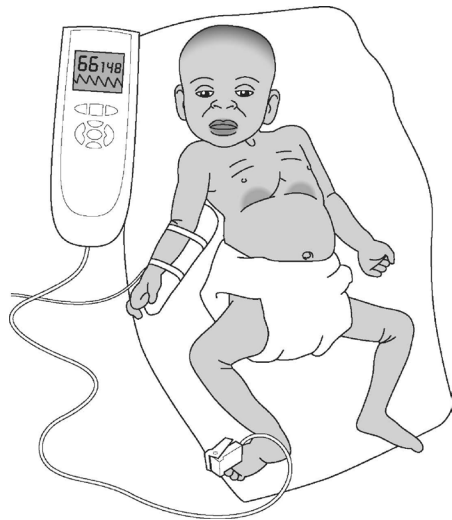

Identification of central cyanosis can be difficult. Examine the tongue or gums (not the lips) under sunlight or the light from an incandescent light bulb (even healthy people may look slightly blue under fluorescent light). If unsure, compare the colour of the child's tongue with that of the mother's. Blue discoloration of the nail-beds indicates peripheral cyanosis, which can occur with intense vasoconstriction as a

result of hypothermia, exposure to low environmental temperature or circulatory shock. Sometimes, peripheral cyanosis occurs without hypoxaemia.

In children with severe anaemia or with heavily pigmented mucous membranes, cyanosis may be detectable only at severe levels of hypoxaemia (14). Central cyanosis is insensitive for accurate detection of hypoxaemia, as it is detected in less than 50% of all children with hypoxaemia; it is, however, highly *specific* for detecting hypoxaemia: virtually all children with central cyanosis have hypoxaemia and should therefore receive oxygen (13).

### *Increased respiratory rate*

An increase in respiratory rate (> 70 breaths/min in children aged 2 months to 5 years) is a physiological response to hypoxia, but the respiratory rate is affected by age (15, 16), malnutrition (17), altitude (18, 19) and the presence of anaemia or fever (20). It is best measured by observing the movement of the chest wall over 60 s (21).

Most of the studies that suggest that an increased respiratory rate is a useful indicator of hypoxaemia were conducted at high altitude (18, 19). At sea level, it is a poorer predictor (22), and the results depend on the cut-off point selected. With a higher cut-off, fewer children will be identified, but a higher proportion of them will have hypoxaemia (15, 23). In most circumstances, tachypnoea alone (with no other signs of severe respiratory distress or hypoxaemia) is not a useful indicator for oxygen therapy (12).

### *Coma, severe lethargy, prostration or prolonged convulsions*

Coma or prolonged convulsions (lasting more than a few minutes) put a child at significant risk for hypoxaemia. These conditions may be associated with depression of the respiratory drive, leading to hypoventilation, or may compromise airway protection and lead to aspiration. Coma is a nonspecific sign of hypoxaemia: many children with long-standing coma do not have hypoxaemia. All children with coma should be examined closely for other clinical signs indicating hypoxaemia (cyanosis, chest indrawing) or airway obstruction (stridor) and should be given oxygen if there is any uncertainty. Children in a coma because of an acute illness (such as meningitis, trauma, cerebral malaria) or with prostration and those who have prolonged convulsions should receive oxygen immediately. At the same time, it is vital to ensure a patent airway, protect the airway from further compromise (such as aspiration) and ensure adequate breathing (ventilation).

### *Severe lower chest indrawing*

Chest indrawing is the inward movement of the lower chest with inspiration (see Fig. 4). In lower chest wall indrawing, the lower chest wall goes in when the child breathes in; if only the soft tissue between the ribs or above the clavicle goes in when the child breathes, this is not lower chest wall indrawing. Because chest indrawing is a key sign in the diagnosis and classification of pneumonia, many children hospitalized for pneumonia may display it to some degree. It is therefore difficult to quantify the usefulness of severe indrawing in predicting hypoxaemia. In the absence of pulse

oximetry to confirm whether hypoxaemia is present, children with severe lower chest indrawing should be classified as having severe respiratory distress and given oxygen. Where oxygen supplies are limited, do not use severe chest indrawing alone as a sign to give oxygen (12).

**Fig. 4. Severe lower chest wall indrawing indicates that this child needs oxygen.**

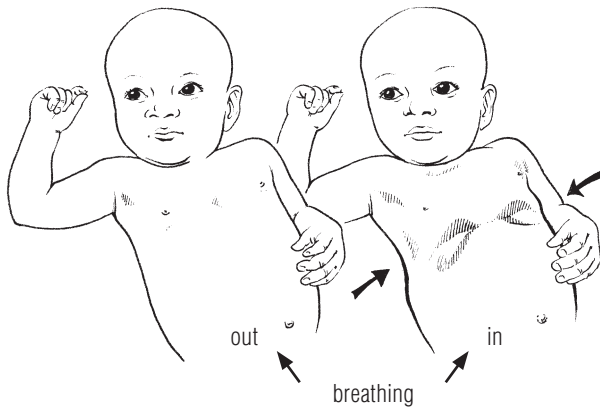

#### *Head nodding, grunting or nasal flaring*

Grunting on expiration with every breath and nasal flaring are important signs of severe respiratory distress, especially in infants, and indicate the immediate need for oxygen.

In head nodding, the head nods downwards towards the chest each time the child breathes in as a result of the use of accessory muscles in breathing. The usefulness of this sign has not been widely studied. Two studies at the same site showed that most children with this sign are hypoxaemic; however, many hypoxaemic children do not have this sign (22, 24).

#### *Crepitations or crackles*

Crepitations or crackles are abnormal respiratory sounds that can be heard with a stethoscope, resulting from the passage of air through fluid in the respiratory tract (either the bronchi or alveoli). Several studies have found this sign to be significantly associated with hypoxaemia, particularly in younger children (15, 24, 25). It may be difficult for staff without training in the use of a stethoscope to distinguish this sound.

#### *Inability to drink*

In a young infant, inability to feed means taking less than half the usual amount during breastfeeding or bottle-feeding. In an older child, it usually means not being able to drink at all. These cases include infants or children who are too weak to drink

---

when offered fluids, who are unable to suck or swallow or who vomit repeatedly and keep nothing down. Although breastfeeding children may have difficulty sucking when their noses are blocked, if they are not severely ill they can still breastfeed when their nose is cleared; this should not be classified as “inability to drink”. Inability to drink is a nonspecific sign of hypoxaemia: less than half of children with this sign have hypoxaemia.

## **3.2 Pulse oximetry**

A pulse oximeter measures oxygen saturation of haemoglobin in the blood by comparing the absorbance of light of different wavelengths across a translucent part of the body. Pulse oximetry is the best method available for detecting and monitoring hypoxaemia.

### **3.2.1 Clinical use**

Even the best combinations of clinical signs commonly lead to misdiagnosis of hypoxaemia in some patients with normal oxygen saturation or fail to detect some hypoxaemic patients. Pulse oximetry correctly identified hypoxaemia in 20–30% more children than with signs alone (7, 22, 24). When used correctly, pulse oximetry allows reliable monitoring with little or no distress to the patient and is an accepted standard for detecting hypoxaemia (26).

As not all patients with signs sometimes associated with the hypoxaemia have this condition, use of pulse oximetry can also reduce unnecessary oxygen administration, thus ensuring the most efficient use of an expensive resource. The technology is robust, and the price of pulse oximeters is now lower than in the past. Pulse oximetry is an important intervention in hospitals in which large numbers of children with acute respiratory disease are cared for (27). Pulse oximetry should therefore be performed on all patients admitted to an inpatient ward with respiratory illness, emergency signs or any sign of hypoxaemia. During triage, all patients with clinical signs of hypoxaemia and children and neonates with any “emergency or priority” sign should be screened by pulse oximetry (see below) (28), to ensure identification of patients most likely to be hypoxaemic.

### **3.2.2 Features of a pulse oximeter**

#### *Alarm*

A low-battery alarm is essential to alert health workers when the machine should be plugged into a power supply (alternating current [AC] mains). A pulse oximeter must be connected to mains power whenever it is not being used in the ward. If the internal battery discharges, the pulse oximeter will work only if it is plugged into the mains, and its usefulness as a portable monitoring tool will be limited.

#### *Sensors*

A wide range of probes is available in different sizes. It is important to choose a sensor probe that is appropriate to the size of the patient. Some are disposable; they can be

---

EMERGENCY SIGN	PRIORITY SIGN	SIGN OF HYPOXAEMIA
<p>Emergency signs include:</p> <ul style="list-style-type: none"> <li>• obstructed or absent breathing</li> <li>• severe respiratory distress</li> <li>• central cyanosis</li> <li>• signs of shock: cold hands, capillary refill time &gt; 3 s, high heart rate with weak pulse, and low or unmeasurable blood pressure</li> <li>• coma or seriously reduced level of consciousness</li> <li>• convulsions</li> <li>• signs of severe dehydration in a child with diarrhoea: lethargy, sunken eyes, very slow return of the skin after pinching or any two of these</li> </ul>	<p>Priority signs that must also be recognized are:</p> <ul style="list-style-type: none"> <li>• <b>T</b>iny infant: any sick infant aged &lt; 2 months</li> <li>• <b>T</b>emperature: child is very hot</li> <li>• <b>T</b>rauma or other urgent surgical condition</li> <li>• <b>P</b>allor (severe)</li> <li>• <b>P</b>oisoning (history of)</li> <li>• <b>P</b>ain (severe)</li> <li>• <b>R</b>espiratory distress</li> <li>• <b>R</b>estless, continuously irritable or lethargic</li> <li>• <b>R</b>eferral (urgent)</li> <li>• <b>M</b>alnutrition: visible severe wasting</li> <li>• <b>O</b>edema of both feet</li> <li>• <b>B</b>urns (major)</li> </ul> <p>These signs can be remembered from the mnemonic <b>3TPR MOB</b>.</p>	<p>Oxygen should be given to children with any of the following signs:</p> <ul style="list-style-type: none"> <li>• SpO<sub>2</sub> &lt; 90%</li> <li>• central cyanosis</li> <li>• nasal flaring</li> <li>• inability to drink or feed (when due to respiratory distress)</li> <li>• grunting with every breath</li> <li>• depressed mental state (i.e. drowsy, lethargic)</li> </ul> <p>In some situations, and depending on the overall clinical condition, children with the following less specific signs may also require oxygen:</p> <ul style="list-style-type: none"> <li>• severe lower chest wall indrawing</li> <li>• respiratory rate ≥ 70/min</li> <li>• head nodding, i.e. a nodding movement of the head, synchronous with respiration and indicating severe respiratory distress</li> </ul>

**Fig. 5. A nurse checks an infant for hypoxaemia with a pulse oximeter on admission**

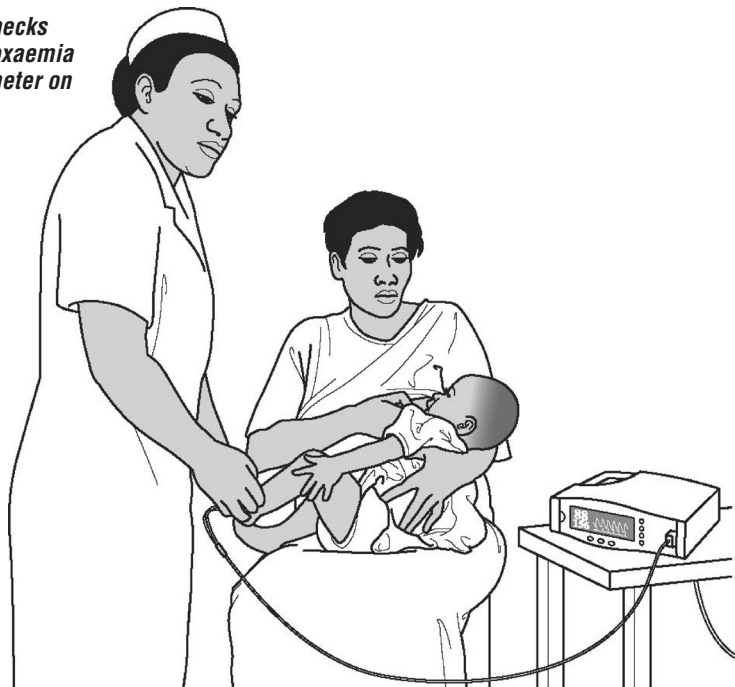

reused for several patients, but they are difficult to clean, and the adhesive wears off after a few uses. There are several types of longer-life digital probes, which are more expensive but durable. For adults, there are hard plastic finger clips (Fig. 6); these will not attach well to infants or children.

**Fig. 6. Hard plastic finger clip for adults**

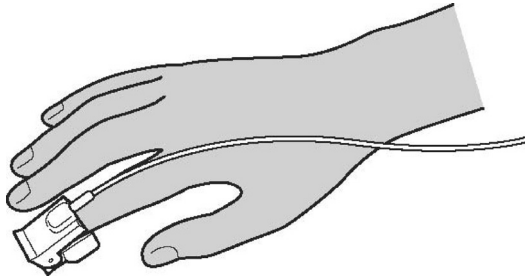

A type of probe that can be used for patients of all ages and sizes is a device with a soft rubber pocket (Fig. 7). As the casing is soft, the probe generally moulds to the digits of children and adults. These soft probes are ideal for spot checks and daily monitoring, as they do not require adhesive.

**Fig. 7. Soft rubber sensor probe**

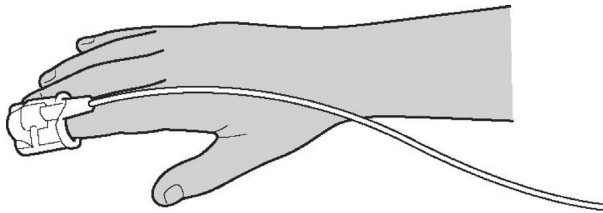

Another alternative is the “Y-sensor” digital probe (Fig. 8), but these require some form of attachment to the hand, foot, toe or finger. They can be ideal for neonates and young children and can be attached to the foot or hand of very low-birth-weight neonates. Some probes are designed to be attached to the ear lobe, but they are generally less useful for a range of ages or for spot checks and daily monitoring.

**Fig. 8. Y-sensor probe**

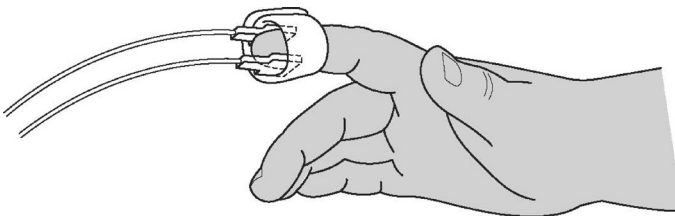



The probes and connecting cables are delicate and are easily damaged if stepped on. Cables break more frequently as the pulse oximeters age. Finger clip-on sensors last about 6 months on average and can be used on many children during this time (27). It is important always to have a spare probe available in case one fails.

### Displays

Examples of pulse oximeter displays showing normal and abnormal readings are given below.

**Fig. 9** shows a pulse oximeter with a normal reading (pulse rate = 102 beats/min;  $\text{SpO}_2 = 97\%$ ) and a plethysmographic (pulse) wave indicating a good arterial trace and a valid reading.

**Fig. 9. Pulse oximeter showing a normal reading**

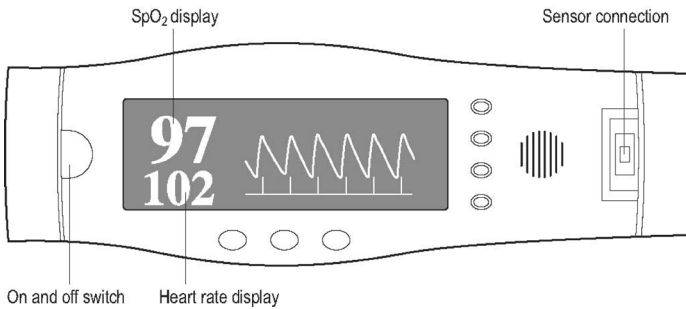

**Fig. 10** shows an abnormal reading (pulse rate = 55 beats/min;  $\text{SpO}_2 = 83\%$ ). In this case, the plethysmographic (pulse) wave is uneven, indicating a poor arterial trace. The accuracy of the heart rate reading should be checked by comparing the number on the pulse oximeter display with auscultation of the heart and counting the true beats. A poor pulse waveform on the pulse oximeter, as in this case, is usually due to inadequate attachment of the sensor probe to the skin, especially on an active child, or to poor peripheral perfusion. This  $\text{SpO}_2$  reading is not valid, and the probe should be repositioned.

**Fig. 10. Pulse oximeter showing a poor plethysmographic (pulse) wave**

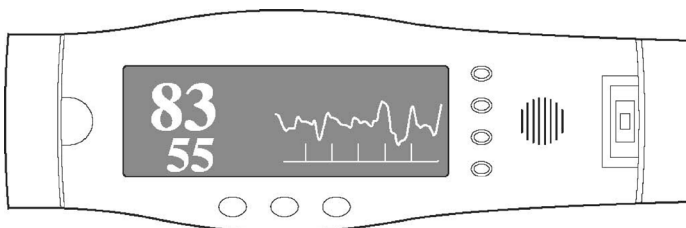

In **Fig. 11** (pulse rate = 150 beats/min; SpO<sub>2</sub> = 82%), the pulse oximeter has a good plethysmographic wave, indicating a valid arterial trace. Therefore, the SpO<sub>2</sub> reading, which is abnormally low (82%), is accurate and indicates that the patient is hypoxaemic. Oxygen should be given. Note the increased heart rate, which is common in seriously ill patients.

**Fig. 11. Pulse oximeter showing a good plethysmographic (pulse) wave and low oxygen saturation**

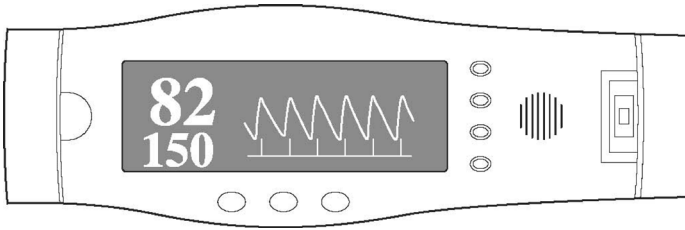

### 3.3 Blood gas analysis

Blood gas analysis can be used to measure the PaO<sub>2</sub> and carbon dioxide in arterial (or venous or capillary) blood. It also indicates the blood pH, which is often abnormal in seriously ill patients: metabolic acidosis (low blood pH) is commonly seen when there is major disturbance of the circulation, as in severe dehydration, severe sepsis and severe malaria. Thus, blood gas analysis provides information on oxygenation, ventilation and circulation, and electrolyte concentrations (particularly sodium and potassium) are measured in the same blood sample and analyser. Electrolyte abnormalities are common in seriously ill patients.

Blood gas analysis has several drawbacks. The analysers are more expensive and require more resources than pulse oximeters (see **Table 1**); the procedure is invasive, painful and distressing to children and infants; and the analysis provides information for only one time. Furthermore, without an arterial cannula for repeated blood sampling, arterial blood gas analysis is rarely a practical means for monitoring changes in response to therapy. Venous and capillary blood are easier to monitor than arterial blood but are of no use for determining oxygenation.

Inaccurate information can result from many factors, such as a poorly taken sample (especially from a struggling or uncooperative child), delay in transfer to a laboratory, inadequate storage conditions before analysis and inadequate maintenance or quality control in the laboratory.

Blood gas analysis requires expensive chemical reagents, resulting in high recurrent costs. Lack of consumables, including reagents, is one of the most common reasons that medical equipment is under-used (29).

Nevertheless, blood gases provide information that cannot be obtained with pulse oximetry. The carbon dioxide level in arterial blood helps in assessing alveolar

ventilation and monitoring trends in the efficiency of ventilation. The pH is a direct indicator of overall acid–base status in arterial, arterialized capillary and venous blood. The probable cause of pH disturbances can be inferred only from the partial pressure of carbon dioxide and the blood bicarbonate concentration (or the base excess or deficit). In sick children in developing countries, metabolic acidosis is the commonest pH abnormality, occurring in severe sepsis, severe diarrhoea and severe malaria due to hypovolaemia or shock. Less common but important conditions include diabetic ketoacidosis, predominantly due to the accumulation of ketone bodies, and some cases of poisoning with acidic compounds, such as aspirin overdose, ethylene glycol ingestion and carbon monoxide intoxication.

**Table 1. Comparison of pulse oximetry and blood gas analysis**

FACTOR TO BE CONSIDERED	PULSE OXIMETRY	ARTERIAL BLOOD GAS
Pain and distress to patient	Minor discomfort from being held	Major discomfort from blood sampling
Risk to staff	Nil	Potential for needle stick injury
Suitability for monitoring	Continuous or regular spot checks	Information for only a single time
Cost	Low to moderately expensive <sup>a</sup> plus moderate recurrent costs (sensor probes)	Very expensive plus high recurrent costs for reagents and maintenance
Skill required	Use and interpretation can be taught to nurses and non-specialist health workers.	High level of laboratory expertise and skill in clinical interpretation
Indication of ventilation adequacy	Useful information on ventilation only for children breathing room air; gives no indication of ventilation for children on supplemental oxygen	Yes
Indication of acid-base state or electrolytes	No	Yes
Major sources of error	<ul style="list-style-type: none"> <li>• Poor skin perfusion</li> <li>• Movement artefact</li> <li>• Greater margin of machine error at lower SpO<sub>2</sub></li> </ul>	<ul style="list-style-type: none"> <li>• Uncooperative child</li> <li>• Clotted specimen</li> <li>• Air in syringe</li> <li>• Laboratory handling</li> </ul>

<sup>a</sup> Depending on the model and sophistication of the pulse oximeter; however, robust low-cost models that can be used for the interventions described have become available.

## KEY MESSAGES

- Hypoxaemia can be detected from clinical signs, with a pulse oximeter or by blood gas analysis.
- Pulse oximetry should be used in hospitals for accurate detection of hypoxaemia.
- Where pulse oximetry is not available, clinical signs may provide useful criteria for deciding whether to provide oxygen.
- Blood gas analysis is not suitable for most hospitals with limited resources, as the analysers are expensive and the chemical reagents represent a high recurrent cost.
- Children with any of the following signs are likely to be hypoxaemic: central cyanosis, nasal flaring, inability to drink or feed (when due to respiratory distress), grunting with every breath, and depressed mental state (i.e. drowsy, lethargic).
- In some situations, and depending on the overall clinical condition, children with the following less specific respiratory signs may also be hypoxaemic: severe lower chest wall indrawing, respiratory rate  $\geq 70$ /min and head nodding (i.e. a nodding movement of the head, synchronous with respiration and indicating severe respiratory distress).
- Other clinical conditions that may be associated with hypoxaemia include prolonged convulsions, acute coma, acute neurological problems due to airway obstruction or impaired ventilatory effort, severe sepsis, heart failure or very severe anaemia.

---

## 4. Sources and delivery of oxygen

The sources of oxygen and its delivery depend on the facility and the availability of resources.

### 4.1 Sources of oxygen

The most common sources of oxygen are cylinders, concentrators and pipelines.

**Oxygen cylinders:** Oxygen is produced in manufacturing plants by cooling air until it liquefies, then distilling the liquid to separate pure oxygen, which is then passed through a liquid oxygen pump into cylinders. This is an energy-consuming process and also involves transport of cylinders to and from the bulk supply depot for regular refilling, which is logistically difficult, expensive and often unreliable for small hospitals. This process can lead to irregular oxygen supplies.

**Oxygen concentrators:** Concentrators draw in air from the environment, which usually contains 21% oxygen, 78% nitrogen and 1% other gases, and extract the nitrogen to leave almost pure oxygen. Most concentrators supply oxygen at a concentration of 90–96%. They provide a safe, less expensive, reliable, cost-efficient source of oxygen, which is more convenient than oxygen cylinders, particularly for low-resource settings. They can provide a continuous supply of oxygen for up to four patients at the same time when used with flow splitters or flow meters. Concentrators nevertheless require regular maintenance to ensure proper functioning and a source of continuous power. Concentrators can be run on AC mains power, a power generator or solar power. Having a power-independent oxygen source, such as a cylinder, as a back-up is important.

**Central piped oxygen:** In many larger hospitals, oxygen is distributed through a system of copper pipes from a central source, usually located outside the building. The source may be liquid oxygen, high-pressure gaseous oxygen cylinders, a large oxygen concentrator or a combination. Pipeline systems supply oxygen at high pressure to equipment such as anaesthetic machines and ventilators. A pipeline system has many advantages: it reduces the risk of fire and obviates handling and transporting heavy cylinders between hospital wards. The high cost of installing centralized oxygen sources with copper pipelines and their maintenance make these systems of oxygen delivery unsuitable for many district-level hospitals in developing countries.

## RECOMMENDATION ON OXYGEN SOURCES

RECOMMENDATION	QUALITY OF EVIDENCE
Effective oxygen delivery systems should be a universal standard of care and should be made more widely available.	Strong recommendation ( <i>expert opinion</i> )

### 4.2 Methods of delivery

This section describes the attachments that link the oxygen source (cylinder, concentrator, piped) with the patient. The methods and attachments described can be used regardless of what source of oxygen is used (see [Table 2](#)).

The methods used to deliver oxygen should be safe, simple, effective and inexpensive. The different delivery methods have been reviewed (12, 30); the methods are non-invasive (through a face mask, head box, incubator or tent or holding tubing close to an infant's face) or semi-invasive (insertion of prongs or catheters into the upper airway). Semi-invasive delivery methods require a low oxygen flow and are cheaper than non-invasive methods, which require high oxygen flow. Nasal and nasopharyngeal catheters have a beneficial effect on lung function, as they produce a positive end expiratory pressure (PEEP)<sup>1</sup> of up to 5 cm H<sub>2</sub>O to improve oxygenation (31). PEEP production may also be effective in the management of apnoea associated with prematurity or bronchiolitis (32).

The main complications associated with oxygen delivery methods are hypercapnoea (from head boxes and face-masks when inadequate flow is used), dislodgement (nasal prongs) and catheter or upper airway obstruction or nasal bleeding (10). Uncontrolled high PEEP due to inappropriately high oxygen flow through nasal prongs or catheters can lead to gastric distension or pneumothorax.

## RECOMMENDATIONS ON OXYGEN DELIVERY METHODS

	RECOMMENDATION	QUALITY OF EVIDENCE
1.	Nasal prongs are the preferred method of delivering oxygen to infants and children < 5 years of age with hypoxaemia who require oxygen therapy.	Strong recommendation ( <i>moderate-quality evidence</i> )
2.	Where nasal prongs are not available, nasal or nasopharyngeal catheters can be used as alternative delivery methods. Face-masks and head boxes are not recommended.	Strong recommendation ( <i>moderate-quality evidence</i> )
3.	Standard flow rates for oxygen through nasal prongs or nasal catheters are 0.5–1 L/min for neonates, 1–2 L/min for infants, 1–4 L/min for older children	Strong recommendation ( <i>moderate-quality evidence</i> )

<sup>1</sup> Pressure in the lungs (alveolar pressure) above atmospheric pressure (pressure outside of the body) at the end of expiration

Face-masks, head boxes, incubators and tents are not recommended because they waste oxygen and are potentially harmful. The recommended methods for neonates, infants and children are nasal prongs, nasal catheters and nasopharyngeal catheters. Patients with a nasopharyngeal catheter should be closely monitored, as they can develop serious complications if the catheter enters the oesophagus.

Nasal prongs are the preferred oxygen delivery method in most circumstances for an optimal balance between safety, efficacy and efficiency. One of the disadvantages of nasal prongs is their cost, which is presently higher than that of catheters (33). This is why nasal catheters are often used in developing countries. If they are unavailable, even a cut-down nasogastric tube can suffice as a nasal catheter through which oxygen can be delivered. They are the best method for delivering oxygen to infants and children with croup or pertussis (whooping cough) to avoid provoking paroxysms of coughing.

### *Nasal prongs*

Nasal prongs are a device that ends in two short tapered tubes (about 1 cm in length) designed to lie just within the nostrils (Fig. 12). They are also called nasal cannulae. Standard flow rates through nasal prongs are 0.5–1 L/min for neonates, 1–2 L/min for infants, 1–4 L/min for older children.

There is no risk of gastric distension at standard flow rates, as they cannot be inserted too far into the nasal passage. Humidification is not required with standard oxygen flow rates, as the natural nasal mechanisms heat and humidify the inspired oxygen (34).

**Fig. 12. Nasal prongs correctly positioned and secured**



There is a slight risk that the airway will become obstructed by mucus (35), especially if a high flow with no humidification is used. The fraction of inspired oxygen ( $\text{FiO}_2$ )<sup>2</sup> depends on the oxygen flow rate, the relation between prong and nasal diameters and the patient's body weight, which partly determines the volume delivered per minute.

<sup>2</sup> Assumed percentage oxygen concentration participating in gas exchange in the alveoli. Natural air contains 20.9% oxygen, which is equivalent to an  $\text{FiO}_2$  of 0.21 or 21%. Patients provided with oxygen-enriched air breathe air with an  $\text{FiO}_2$  higher than in the atmosphere.

In infants weighing up to 10 kg, oxygen flows of 0.5 L/min, 1 L/min and 2 L/min result in  $\text{FiO}_2$  values of about 35%, 45% and 55%, respectively (36). PEEP production with nasal prongs is unpredictable.

Achievement of PEEP depends on the distal prong diameter, the oxygen flow and body weight. Whereas 1 L/min of oxygen may produce a PEEP of about 5 cm  $\text{H}_2\text{O}$  in premature infants, there is no significant PEEP production with the same flow in infants weighing up to 10 kg (30).

### Practical considerations

The distal prong should fit well into the nostril (premature infants: 1 mm, infants weighing up to 10 kg: 2 mm). The prongs should be secured with a piece of tape on the cheeks near the nose, as shown in Fig. 12. Care should be taken to keep the nostrils clear of mucus to avoid blockage. The maximum flow rate without humidification is 1 L/min in neonates, 2 L/min in infants, 4 L/min in preschool children and 6 L/min in school-children. Higher flow rates without effective humidification may cause drying of nasal mucosa, with associated bleeding and airway obstruction.

A nasal catheter is a thin, flexible tube that is passed into the nose and ends with its tip in the nasal cavity (see box below and Fig. 13). Nasal catheters are usually well tolerated, and they are unlikely to be dislodged. The oxygen does not have to be humidified because the tip of the catheter lies in the nasal cavity. Catheters can become blocked with mucus, which can cause upper airway obstruction. There is little risk of displacement into the oesophagus, with a consequent risk of gastric distension. Ideally, a nasogastric tube should be in place to decompress the stomach if distension occurs.

Actual  $\text{FiO}_2$  values or PEEP achieved with nasal catheters have not been published. Nasal catheters are less efficient in improving oxygenation than nasopharyngeal catheters (37) but are associated with fewer complications.



**Fig. 13.** Correct position of nasal catheter (cross-sectional view)



### Practical considerations

In neonates and infants, 8-French (F) size catheters should be used. A catheter passed for a distance equal to the distance from the side of the nostril to the inner margin of the eyebrow usually reaches the posterior part of the nasal cavity. In infants, this is about 2.5 cm. The tip of the catheter should **not** be visible below the uvula. A catheter is easily secured with tape above the upper lip. The maximum flow rate should be set at 0.5–1 L/min for neonates and 1–2 L/min for infants and older children. A nasogastric tube should be in place at the same time, in the same nostril so as not to obstruct both nostrils. Higher flow rates without effective humidification may cause drying of the nasal mucosa, with associated bleeding and airway obstruction.

### Nasopharyngeal catheters

This type of catheter is passed to the pharynx just below the level of the uvula (see box below and Fig. 14). Oxygen delivery through a nasopharyngeal catheter is the most economical of all the methods described here. Better oxygenation is achieved with a lower oxygen flow than with nasal prongs (35), because of the relatively high  $\text{FiO}_2$  in the trachea and significant PEEP production: in infants, 1 L/min of nasopharyngeal oxygen given through an 8-F catheter produces a PEEP of 2.8 cm  $\text{H}_2\text{O}$  (31, 34).

**Fig. 14. Insertion of a nasopharyngeal catheter**

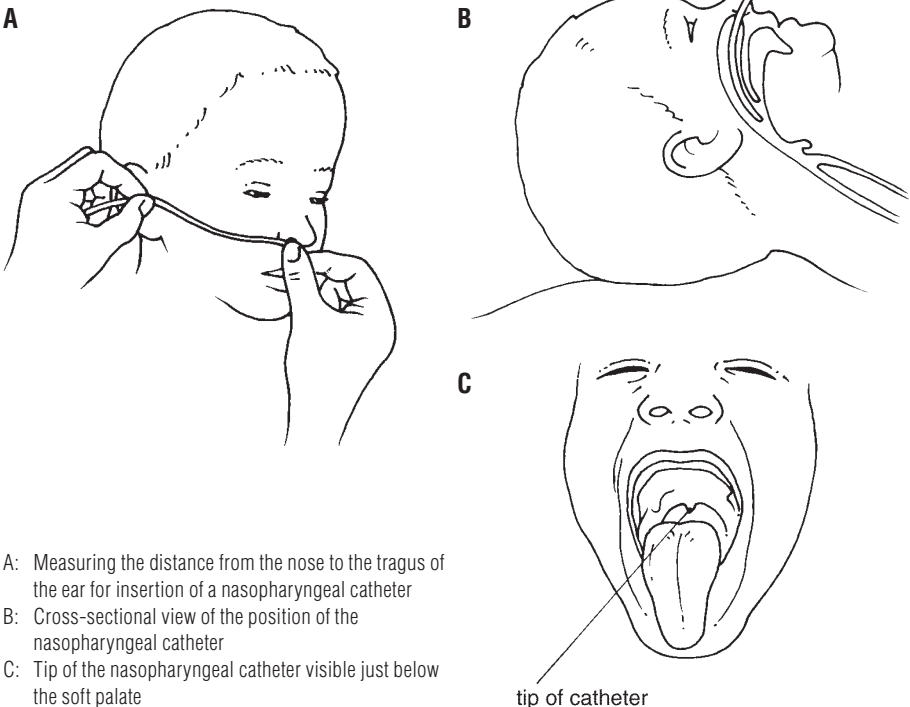

Nevertheless, certain problems associated with nasopharyngeal catheters require close supervision (33). Thus, in most settings where frequent monitoring is difficult, nasal prongs or nasal catheters are the preferred method, except in children with severe hypoxaemia. Nasopharyngeal catheters are prone to blockage with mucus, and accumulation of mucus can cause upper airway obstruction (35, 38). As oxygen given through a nasopharyngeal catheter bypasses the humidifying and warming properties of the nose, effective external humidification is essential to avoid drying of the pharyngeal mucosa and to reduce the likelihood of thickened secretions blocking the catheter (39).

Nasopharyngeal catheters can be displaced downwards into the oesophagus and cause gagging, vomiting and gastric distension. Their use should therefore be limited to situations in which nasal prongs are unavailable, staff are familiar with the insertion technique and with supervision, the oxygen supply is limited and in the case of children in whom cyanosis or oxygen desaturation is not relieved by oxygen given via nasal prongs or a nasal catheter.

### **Practical considerations**

Nasopharyngeal catheters are inserted into the nose to a depth 1 cm less than the distance from the side of the nose to the front of the ear (tragus). In infants, this distance is about 7 cm. Like nasal catheters, nasopharyngeal catheters can easily be secured in place with tape. In neonates and infants, 8-F catheters should be used. The maximum flow rate should be set at 0.5 L/min for neonates and 1 L/min for infants. Higher flow rates without effective humidification may cause drying of the nasal mucosa, with associated bleeding and airway obstruction. Because there is a risk for gastric distension with downward dislodgement of the catheter tip, a nasogastric tube should also always be in place (passed through the same nostril) to permit rapid decompression of the stomach (40). The catheter should be removed and cleaned at least twice a day (41). Humidification is always required, and the humidifier should be filled to the correct level with previously boiled, clean water.

Because of reliable production of moderate PEEP, oxygen administration by a nasopharyngeal catheter retains a place in the management of patients with severe hypoxia and/or apnoea (associated with prematurity or bronchiolitis). Nasopharyngeal oxygen delivery may also be used in hospitals with very limited oxygen supply, provided that sufficiently trained personnel are available for monitoring and supervision.

### *Head boxes, incubators, tents and face-masks*

Non-invasive methods of oxygen administration have some advantages: with oxygen piped into a head box, incubator or tent, the actual  $\text{FiO}_2$  can be determined precisely with an oxygen analyser placed near the infant's mouth. There is no increased risk for airway obstruction by mucus or of gastric distension, and humidification is not necessary. The disadvantage of these methods is, however, of major concern: carbon

dioxide toxicity can occur if the flow of oxygen is inadequate. This can result from setting the oxygen flow too low or from kinking or disconnection of the oxygen tubing.

When a head box is used with an inappropriately tight seal around the infant's neck, carbon dioxide can be retained. A gas flow of 2–3 L/kg per min is necessary to avoid rebreathing of carbon dioxide in a head box (30). Head boxes, face-masks, incubators and tents all require high oxygen flows to achieve adequate concentrations of oxygen and avoid carbon dioxide accumulation, and they are therefore expensive and wasteful. Head boxes and face-masks also interfere with feeding. Therefore, these methods are not recommended for oxygen administration, especially in settings where oxygen supplies are limited.

### *Oral catheters*

Experience with oropharyngeal delivery of oxygen to children is limited, and the technique cannot be recommended. Daga et al. (40), who described this method, introduced an 8-F feeding tube through the mouth into the hypopharynx, equal in length to the distance from the side of the nose to the tragus of the ear. The tube was changed once a day. They reported adequate oxygenation of preterm infants with respiratory distress and of infants with pneumonia with an oxygen flow rate of 0.5–1 L/min. There were no instances of tube dislodgement or blockage. The authors claimed that this method allows unobstructed gas exchange through both nostrils, with feeding and oxygen tubes both by the oral route.

**Table 2** gives comparative values for the different methods of oxygen administration.

## KEY MESSAGES

- The commonest sources of oxygen are oxygen cylinders, oxygen concentrators and central oxygen pipelines.
- The devices for giving oxygen to a patient include nasal prongs, nasal catheters, nasopharyngeal catheters, head boxes, incubators, tents and face-masks.
- Nasal prongs and nasal and nasopharyngeal catheters are the most efficient means for delivering oxygen.
- Nasal prongs are the preferred oxygen delivery method in most circumstances for an optimal balance between safety, efficacy and efficiency.
- For neonates, infants and children, the use of head boxes, face-masks, incubators and tents to deliver oxygen is generally discouraged, as they are wasteful of oxygen and potentially harmful (due to carbon dioxide toxicity).
- Humidification is necessary only with methods of oxygen delivery that bypass the nose; it is generally not necessary when oxygen is delivered through a nasal catheter or nasal prongs.
- Humidification is essential when cold oxygen is delivered from a cylinder through a nasopharyngeal catheter or when high oxygen flows are used.
- Humidifier reservoirs should be cleaned regularly to avoid bacterial contamination.

**Table 2. Oxygen delivery methods in children and infants**

METHOD	MAXIMUM O <sub>2</sub> FLOW (L/MIN) <sup>a</sup>	ACTUAL INSPIRED O <sub>2</sub> FRACTION (%) FROM 1 L/MIN BY A 5-KG INFANT	PEEP	HUMIDIFICATION	RISK FOR HYPERCAPNOEA	RISK FOR AIRWAY OBSTRUCTION	EQUIPMENT REQUIRED	NURSING DEMAND
Nasal prongs	Neonates: 0.5–1							
	Infants: 2							
	Preschool: 4							
Nasal catheter	School: 6	45	Minimal	Not required	No	Minimal	Nasal prongs	+
	Neonates: 0.5							
	Infants: 1	50	+	Not required	No	+	8-F catheter	++
Nasopharyngeal catheter	Neonates: 0.5							
	Infants: 1	55	++	Required	No	++	8-F catheter, humidifier	+++
Head box, face-mask, incubator, tent	Head box: 2–3 L/kg per min		Nil	Not required	Yes	No	Head box, face-mask	+++

F, French; PEEP, positive end expiratory pressure

<sup>a</sup> Higher flow rates without effective humidification may cause drying of nasal mucosa, with associated bleeding and airway obstruction.

### 4.2.1 Neonates

Oxygen therapy in newborn infants, particularly when they are born preterm, should reflect the fact that in the first hours of life they have lower normal oxygen saturation than older newborns (7, 42). Pulse oximetry should be used to monitor SpO<sub>2</sub>, which should be maintained ≥ 88% but in pre-term babies no higher than 95% to prevent eye damage (41) (refer to [section 4.2.2](#)).

A number of conditions that may lead to hypoxaemia occur more frequently in neonates, notably birth asphyxia, respiratory distress syndrome and transient tachypnoea of the neonate; pneumonia is also common (8). Neonates who are very unwell for reasons such as prematurity, sepsis, seizures or hypoglycaemia are also prone to apnoea. Apnoea and hypoventilation also occur in otherwise-well infants of very low birth weight (< 1.5 kg or gestational age < 32 weeks) because of immature respiratory drive (apnoea of prematurity). Apnoea can lead to hypoxaemia and slowing of the heart rate (bradycardia), further reducing oxygen delivery to tissues.

#### *Respiratory depression at the time of birth: neonatal resuscitation*

Perinatal asphyxia is manifested as slow or absent breathing, hypotonia (floppiness), cyanosis or pallor and bradycardia (slow or absent heart rate) at the time of birth. When newborn term or preterm (> 32 weeks' gestation) infants require positive pressure ventilation, bag-and-mask resuscitation with air containing 21% oxygen is effective. For preterm infants (< 32 weeks' gestation), bag-and-mask resuscitation with 30% oxygen should be used. The primary respiratory problem in most cases of perinatal asphyxia is lack of initiation of ventilation or lack of effective ventilation, so the most important intervention is to assist the neonate to take breaths more effectively.

Sometimes perinatal asphyxia is a complication of neonatal pneumonia, aspiration (of meconium, maternal blood or amniotic fluid) or severe respiratory distress syndrome. In cases of severe neonatal pneumonia or aspiration, effective ventilation must be initiated and supplemental oxygen provided to ensure acceptable oxygenation.

The first priority for asphyxiated infants, therefore, should be adequate inflation of the fluid-filled lungs. Attention should then be paid to the concentration of inspired oxygen to be given (43). Resuscitation of neonates is described in the WHO *Pocket book of hospital care for children* (28).

Respiratory depression at the time of birth may occur if the mother has received opiate drugs (morphine or pethidine) during labour. In these cases, naloxone by intramuscular injection at a concentration of 0.1 mg/kg body weight, with bag-and-mask ventilation, is often effective.

If a neonate remains hypoxic despite being given oxygen, check that the infant is making adequate efforts to breathe and that the chest is rising and falling. If not, bag-and-mask ventilation should be given. Check that oxygen is being delivered to the infant: check the tubing connections for leakage, or try another oxygen source. Cyanosis in neonates will sometimes be due to heart or structural lung problems.

---

An infant who remains cyanosed or has a low SpO<sub>2</sub> despite oxygen and is making good efforts to breathe should be reviewed by an experienced practitioner to assess whether there is another reason for hypoxaemia, such as a diaphragmatic hernia, congenital heart disease, pneumothorax or a congenital lung abnormality.

Eye damage, called retinopathy of prematurity, can result from exposure of very low-birth-weight infants to excessive oxygen. Infants at highest risk are those born at < 32 weeks' gestation or weighing < 1250 g; the smaller the infant, the greater the risk. If pulse oximetry is available, the SpO<sub>2</sub> should be maintained above 88% but no higher than 95%, to prevent eye damage (41). Retinopathy of prematurity can develop even with meticulous monitoring in extremely premature infants who have multiple problems. Most cases resolve spontaneously. All infants born at < 32 weeks' gestation or weighing < 1250 g and larger preterm infants who received oxygen should be screened for retinopathy of prematurity at 4–6 weeks of age.

## KEY MESSAGES

- Newborn infants in the first few hours of life, particularly those who are preterm, have lower normal oxygen saturation than older newborns. The normal level for neonates in the first hours of life is  $\geq 88\%$ .
- In preterm infants born at < 32 weeks' gestation SpO<sub>2</sub> should be maintained between 88% and 95%, and not above 95%, to avoid eye damage.
- **Where pulse oximetry is not available**, oxygen should be given to all neonates who have cyanosis or a respiratory rate > 70/min or who are too sick to feed.
- For neonates who are not breathing at birth, a self-inflating bag and face-mask can effectively provide positive pressure ventilation with room air, but supplemental oxygen may be required in some cases.
- For infants after the immediate neonatal period who have apnoea or depressed respiratory effort, oxygen should be given and respiratory stimulation with bag-and-mask ventilation or continuous positive airway pressure (CPAP) if available (see below) until adequate respiratory effort is restored.
- CPAP is useful in the management of neonates with severe respiratory distress or apnoea and effective, safe methods for delivering bubble CPAP are available. Humidified high-flow nasal prong oxygen therapy also shows promise but requires further evaluation.

### 4.2.2 Children

All children living at  $\leq 2500$  m above sea level should receive oxygen therapy if their oxygen saturation is  $\leq 90\%$ , as measured by pulse oximetry. In children living at high altitude (> 2500 m above sea level), the normal oxygen saturation is lower than those living at sea level, and a level of SpO<sub>2</sub> such as  $\leq 87\%$  could be used as a threshold for giving oxygen.

Where there is no pulse oximetry, clinical signs may be used to guide use of oxygen. Children with any of the following signs are likely to have hypoxaemia:

- central cyanosis,
- nasal flaring,
- inability to drink or feed (when this is due to respiratory distress),
- grunting with every breath and
- depressed mental state (i.e. drowsy, lethargic).

In some situations, and depending on their overall clinical condition, children with the following less specific respiratory signs may also have hypoxaemia:

- severe lower chest wall indrawing,
- respiratory rate of  $\geq 70$ /min or
- head nodding (i.e. a nodding movement of the head, synchronous with the respiration and indicating severe respiratory distress).

Other clinical conditions, such as prolonged convulsions, acute coma or acute neurological problems, may also be associated with hypoxaemia due to an obstructed airway or impaired ventilatory effort.

When the oxygen supply is very limited, give oxygen to children aged  $> 2$  months according to the order of priority suggested in [Table 3](#). Infants aged  $< 2$  months with signs of severe respiratory distress (tachypnoea, severe chest indrawing, head nodding or grunting) should always be given oxygen, because hypoxaemia increases their risks for apnoea and death.

Oxygen should always be given *continuously* until normal saturation is maintained without oxygen.

**Table 3. Clinical indications for oxygen therapy**

CLINICAL PRESENTATION OF SEVERE PNEUMONIA WITH	PRIORITY FOR OXYGEN
Central cyanosis	Very high
Decreased consciousness, unresponsiveness or responsive to painful stimuli only	Very high
Grunting with every breath	Very high
Nasal flaring	Very high
Severe palmar or conjunctival pallor (severe anaemia) with severe lower chest wall indrawing or fast breathing	Very high; high priority should also be given to correcting the underlying abnormality (i.e. blood transfusion and/or antimalarial agents).
Acute coma or convulsions lasting $> 15$ min	Very high until respiratory effort has returned to normal; also, protect airway and ensure adequate ventilation.
Inability to drink or feed	High
Severe chest indrawing	Priority
Respiratory rate $\geq 70$ /min	Priority
Head nodding	Priority

When children are monitored with pulse oximetry, any child with an  $\text{SpO}_2 < 90\%$  should receive oxygen. Children with very severe anaemia, severe heart failure, septic shock or acute neurological illness will certainly benefit more than others from oxygen when the  $\text{SpO}_2$  is 90–94%, as these children are less able to withstand moderately low oxygen levels than children with only lung disease. Children with emergency signs (obstructed or absent breathing, severe respiratory distress, central cyanosis, signs of shock, coma or convulsions) should receive oxygen therapy during the resuscitation phase if their  $\text{SpO}_2$  is  $< 94\%$ .

As the normal  $\text{SpO}_2$  range is lower at higher altitudes, it may be appropriate to give oxygen only at an  $\text{SpO}_2$  of  $\leq 87\%$  to children living at altitudes  $> 2500$  m, if oxygen supplies are limited.

### RECOMMENDED THRESHOLDS FOR ADMINISTERING OXYGEN THERAPY

	RECOMMENDATION	QUALITY OF EVIDENCE
1.	Children with hypoxaemia should receive appropriate oxygen therapy.	Strong recommendation ( <i>low-quality evidence</i> )
2.	Administration of oxygen therapy should be guided by pulse oximetry, when available.	Strong recommendation ( <i>very low-quality evidence</i> )
3.	Children with respiratory disease living at $\leq 2500$ m above sea level should receive oxygen therapy if their oxygen saturation is $\leq 90\%$ , as measured by pulse oximetry.	Strong recommendation ( <i>very low-quality evidence</i> )
4.	Children with emergency signs (obstructed or absent breathing, severe respiratory distress, central cyanosis, signs of shock, coma or convulsions) should receive oxygen therapy during the resuscitation phase if their $\text{SpO}_2$ is $< 94\%$ .	Strong recommendation ( <i>very low-quality evidence</i> )
5.	In children living at high altitude ( $> 2500$ m above sea level), the normal oxygen saturation is lower than in those living at sea level. At high altitude, a lower level of saturation, such as $\text{SpO}_2 \leq 87\%$ , could be used as a threshold for giving oxygen.	Recommendation ( <i>very low-quality evidence</i> )

**Note:** It is strongly recommended that children with oxygen saturation  $< 90\%$  be given oxygen therapy. In areas at high altitudes and with limited resource, oxygen may be given at a lower  $\text{SpO}_2$ , by consensus.

Once oxygen therapy has been initiated, the child must be checked within 15–30 min to observe whether the treatment is working. In severely hypoxaemic children, correction of oxygen may not be complete and clinical signs may remain, or the  $\text{SpO}_2$  may still be low; this does not mean that oxygen therapy has failed, and it should not be abandoned. Other children will deteriorate rapidly or slowly despite receiving oxygen. There are a number of possible causes for lack of response:

1. Oxygen delivery is inadequate. Check that
  - oxygen is flowing (put the end of the tube under water in a beaker and watch for bubbles, or hold the end close to your hand to feel the air flow);



- the oxygen tubing is not leaking;
  - the nasal prongs or nasal catheter are fitted correctly and not blocked; and
  - if the oxygen is being delivered from a concentrator, the concentration of oxygen delivered is adequate (> 85%). When using concentrators it is important to have an oxygen analyser to measure the fraction of oxygen and the flow rate.
2. Other possible causes are listed in the WHO *Pocket book of hospital care for children* (28), section 4, such as
- pleural effusion: listen with a stethoscope for breathing sounds on both sides of the chest; do a chest X-ray;
  - pneumothorax: listen with a stethoscope for breathing sounds on both sides of the chest; do a chest X-ray;
  - upper airway obstruction (e.g. from croup or a foreign body): listen for stridor;
  - bronchospasm (e.g. severe asthma): listen with a stethoscope for wheeze;
  - cyanotic heart disease or congestive heart failure;
  - ventilatory failure: the child's respiratory effort is inadequate, or the child has slow or shallow breathing and is lethargic.
3. If nasal prongs are used at maximum flow (4 L/min for infants and up to 8 L/min) and the child is still hypoxaemic:
- Begin CPAP if the equipment is available (see section 4) or consider mechanical ventilation if your hospital has an intensive care unit.

If CPAP is not available,

- If available, give a second source of oxygen via an oxygen mask (ideally with a reservoir bag) to increase the fractional concentration of inspired oxygen.
- If a second source of mask oxygen is not available, insert a nasopharyngeal catheter to give a higher fractional concentration of inspired oxygen. But *never* use nasal prongs and a nasopharyngeal catheter together.

---

## 5. Continuous positive airway pressure

Continuous positive airway pressure (CPAP) consists of delivery of mild air pressure to keep the airways open. CPAP delivers PEEP<sup>3</sup> with a variable amount of oxygen to the airway of a spontaneously breathing patient to maintain lung volume during expiration. CPAP decreases atelectasis (alveolar and lung segmental collapse) and respiratory fatigue and improves oxygenation (44). It is indicated for infants with severe respiratory distress, hypoxaemia or apnoea despite receiving oxygen (45).

CPAP requires a source of continuous airflow (often an air compressor) and usually requires an oxygen blender connected to an oxygen source. A CPAP system is available in some hospitals but should be used only when it is reliable, when oxygen systems are in place, where staff are adequately trained and when close monitoring is assured.

### 5.1 Bubble CPAP

Bubble CPAP has been used successfully in some referral hospitals in developing countries (46–48). The system has three components:

1. **Continuous gas flow into the circuit:** The gas flow rate required to generate CPAP is usually 5–10 L/min. This alone can generate CPAP, even without additional oxygen ( $\text{FiO}_2 = 0.21$ ),<sup>4</sup> but many neonates require supplemental oxygen. Therefore, the system also usually requires an oxygen blender, which connects an oxygen source (cylinder or concentrator) to the continuous airflow to increase the  $\text{FiO}_2$ .
2. **A nasal interface connecting the infant's airway with the circuit (Fig. 15):** short nasal prongs are generally used to deliver nasal CPAP. They must be carefully fitted to minimize leakage of air (otherwise, CPAP will not be achieved) and to reduce nasal trauma.
3. An **expiratory limb** with the distal end submerged in water to generate end-expiratory pressure: in bubble CPAP, the positive pressure is maintained by placing the far end of the expiratory tubing in water. The pressure is adjusted by altering the depth of the tube under the surface of the water.

Several commercial bubble CPAP machines are available (such as the system illustrated in Fig. 15). The price varies from several hundred US dollars to US\$ 10 000.

---

<sup>3</sup> Positive end-expiratory pressure (PEEP) is the pressure in the lungs (alveolar pressure) above atmospheric pressure (the pressure outside of the body) at the end of expiration.

<sup>4</sup>  $\text{FiO}_2$  is the assumed fraction (or percentage) of oxygen concentration participating in gas exchange in the alveoli; natural air contains 20.9% oxygen, which is equivalent to  $\text{FiO}_2$  of 0.21 or 21%. Patients given oxygen-enriched air breathe air with a higher-than-atmospheric  $\text{FiO}_2$ .

---

**Fig. 15. A bubble CPAP circuit connected to an infant by close-fitting nasal prongs**

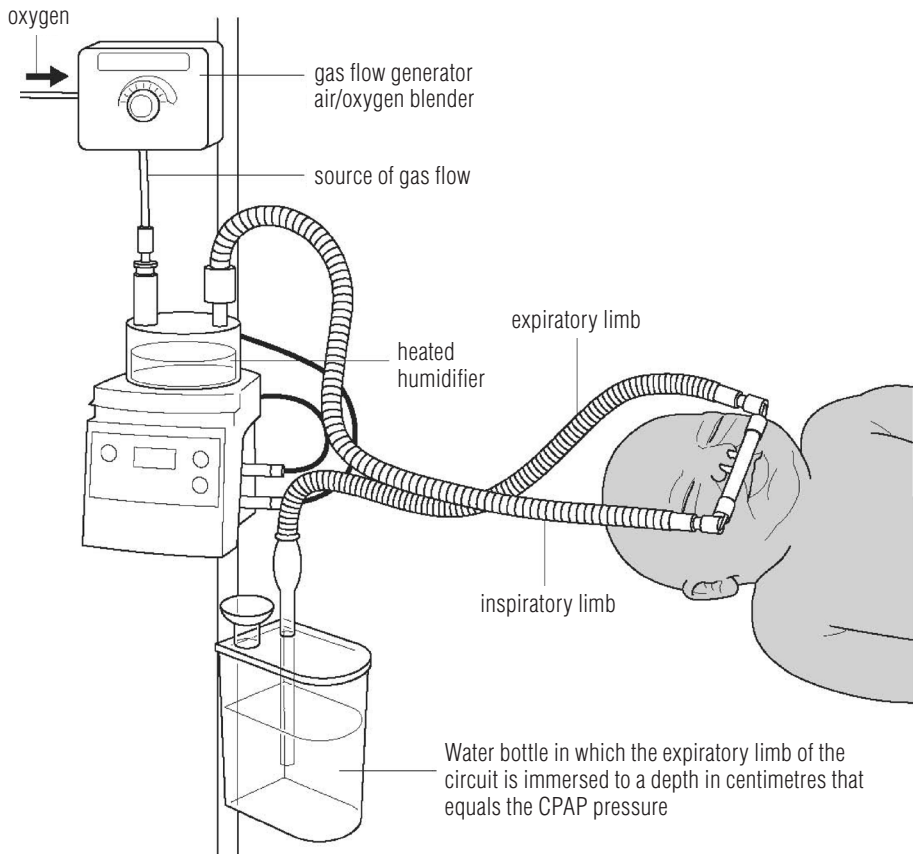

CPAP, continuous positive airway pressure

An inexpensive form of bubble CPAP can be made with standard nasal prongs. The method is shown in [Figs 16 and 17](#). This system is used in several hospitals in Asia (e.g. Dhaka Children's Hospital in Bangladesh) (48).

A gas (oxygen) flow rate of 5–10 L/min is required for older children with pneumonia, while 3–4 L/min may be sufficient to generate CPAP in small neonates. In neonates born < 32 weeks' gestation, pure oxygen is not safe, as a high concentration can cause retinopathy of prematurity. Thus, another source of air flow, such as an air compressor or an oxygen blender, is required for premature infants. In older infants, who require a higher flow to generate CPAP, use of a 10-L/min oxygen concentrator is efficient.

**Fig. 16. An inexpensive bubble CPAP set up with modified nasal prongs**

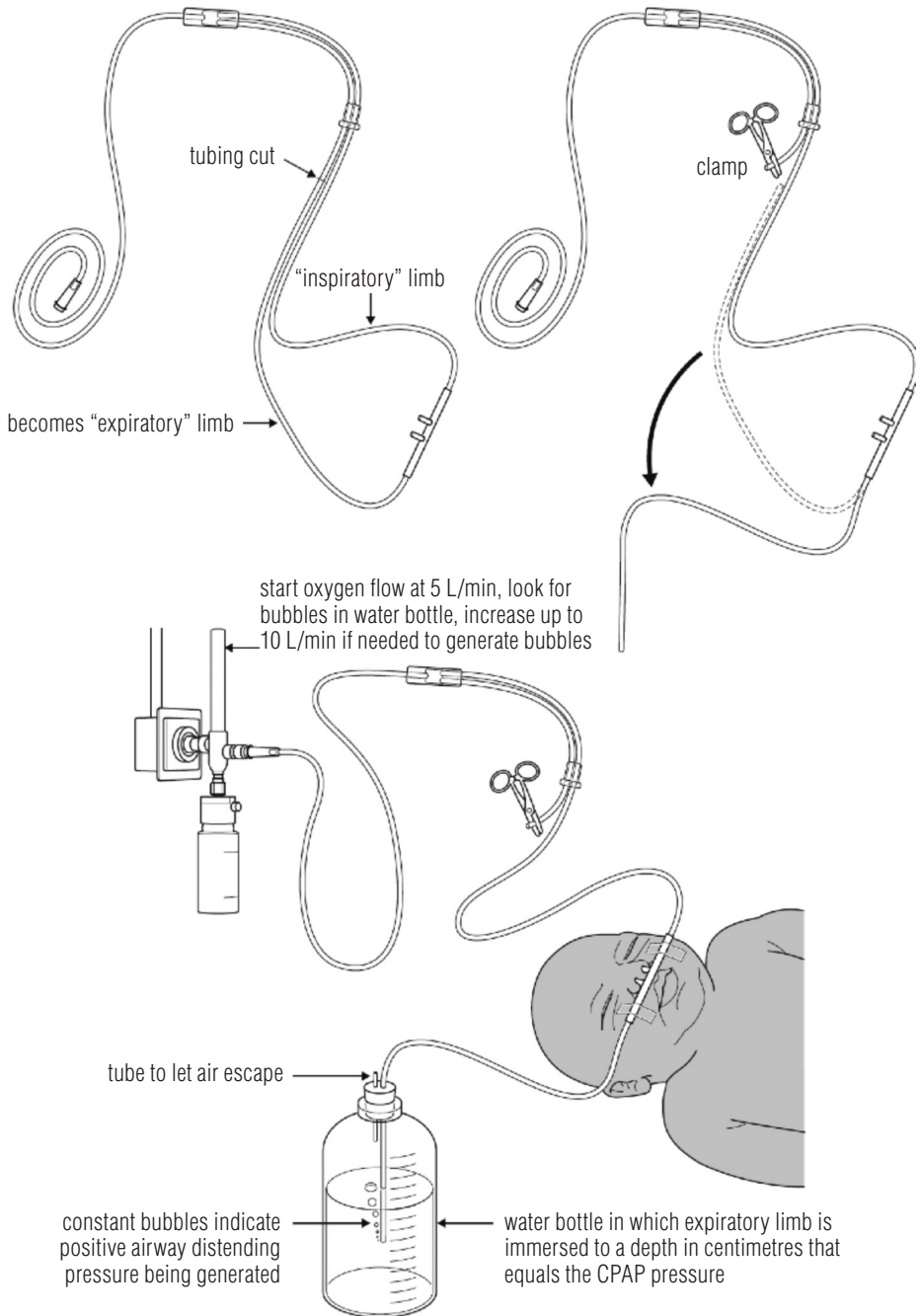

**Fig. 17. Bubble CPAP with inexpensive modified nasal prongs can be run with an oxygen concentrator**

start oxygen flow at 5 L/min, look for bubbles in water bottle, increase up to 10 L/min if needed to generate bubbles

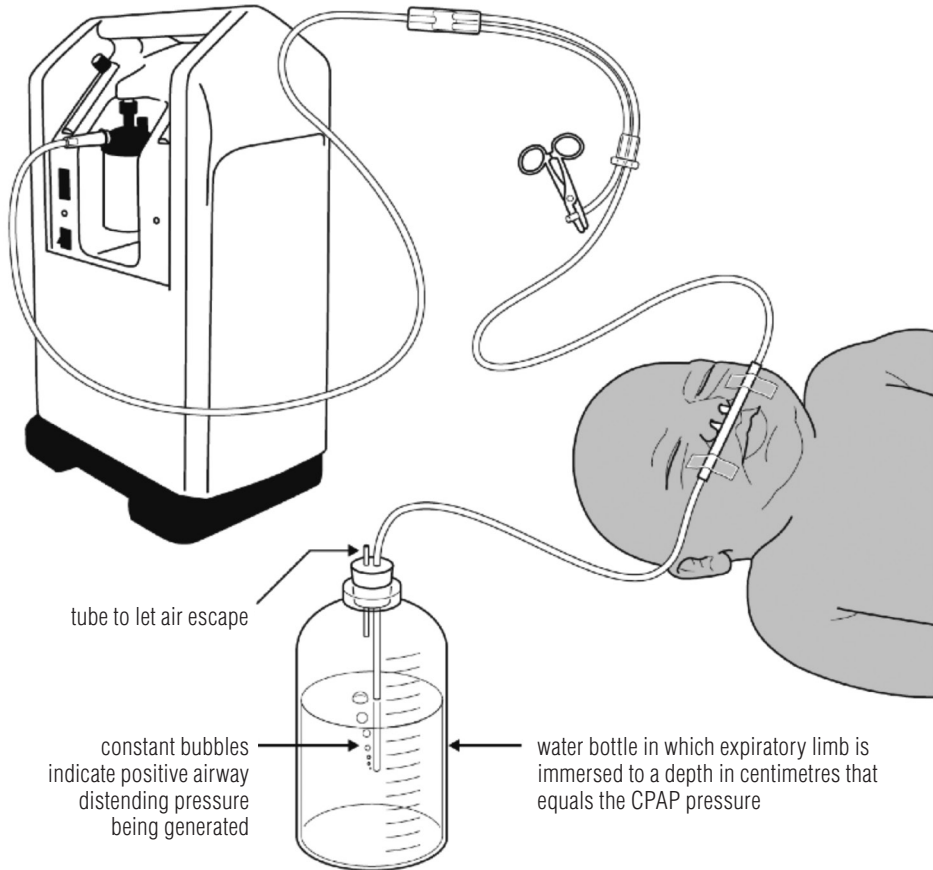

## 5.2 Humidified high flow through nasal prongs in neonates and infants

Experience with this simpler, less expensive method of delivering CPAP to neonates has been reported (49), with a high gas flow (up to 2 L/kg body weight per min) through normal nasal prongs. Higher flows through nasal prongs of an air–oxygen mix with humidification have been used for preterm neonates and infants with very severe pneumonia or bronchiolitis who are failing to respond to standard oxygen flow rates or when ventilation is inadequate (50–53). High-flow CPAP may help to increase lung volume, reduce atelectasis (alveolar and lung segmental collapse) and stimulate breathing in infants with apnoea.

Flow rates of up to 2 L/kg body weight per min through normal nasal prongs have been used as an alternative to CPAP with a mechanical ventilator or bubble

CPAP circuit. This rate delivers 4–5 cm H<sub>2</sub>O of PEEP. It requires special equipment – a source of gas flow, an oxygen blender and a humidifier.

Although PEEP can be generated by this high-flow method, it is not as simple as augmenting flows from a standard oxygen source such as a cylinder or concentrator. The method requires highly effective humidification to prevent drying of the nasal mucosa, to avoid bleeding and nasal obstruction. A heated humidifier is ideal, as an unheated water bubble humidifier may not provide adequate humidification at such high flows.

High-flow CPAP also requires an oxygen and air blender, so that the concentration of inspired oxygen can be controlled. It is often unnecessary and potentially dangerous to deliver a very high concentration of inspired oxygen to the lungs. With high-flow CPAP, there is also a risk for stomach distension and pneumothorax, which must be carefully monitored.

High-flow CPAP through nasal prongs is a promising low-cost method for providing additional respiratory support in hospitals that do not have mechanical ventilators or standard CPAP machines; however, there is limited experience with this method, and the risks described above must be taken into account and addressed. The adequacy of ventilation must be monitored closely, as high flow 100% oxygen can maintain SpO<sub>2</sub> in the normal range despite dangerous hypercarbia and near respiratory failure. CPAP requires humidification and careful monitoring.

## KEY MESSAGES

- Any child with an SpO<sub>2</sub> < 90% should receive oxygen. This rule best applies to health facilities located between sea level and 2500 m above sea level and for altitudes higher than 2500 m where oxygen supplies are ample (such as in concentrators).
- Oxygen should always be given continuously and should not be administered for recurrent short periods (such as every hour or two).
- The child should be examined within 15–30 min of starting oxygen therapy to determine whether the treatment is working. In severely hypoxaemic children, correction may not be complete and clinical signs may remain, or the SpO<sub>2</sub> may still be low. This does not mean that oxygen therapy has failed, and it should not be abandoned. Some children deteriorate rapidly or slowly despite receiving oxygen.

---

## 6. Humidification

Some oxygen delivery methods require use of humidifiers for the patient's comfort. This section outlines when humidification is required and the types of humidifiers recommended.

### 6.1 Rationale

When oxygen is used at a low flow rate (< 4 L/min) through nasal prongs, humidification is not necessary. A study of adults on long-term oxygen through a nasal catheter showed no difference in subjective assessment of nose symptoms with humidified and non-humidified oxygen (34). More than 40% of patients complained of dry nose and dry throat, but the symptoms were relatively mild and did not increase significantly when oxygen was administered without prior humidification. Delivery of oxygen at standard flow rates through nasal prongs or a catheter does not require humidification.

Humidification is needed when oxygen is given via a nasopharyngeal catheter and for all patients with an endotracheal tube or a tracheostomy. A study in the Gambia showed a higher rate of nasal obstruction by mucus in children receiving oxygen by nasopharyngeal catheter, and it was suggested that this might have been due partially to dry oxygen (35). In general, humidification is not required in tropical climates if oxygen is delivered from a concentrator rather than a cylinder, as concentrators provide oxygen at room temperature, whereas cylinders deliver cold oxygen.

### RECOMMENDATIONS ON HUMIDIFICATION

	RECOMMENDATION	QUALITY OF EVIDENCE
1.	When oxygen is delivered at a standard flow rate (0.5–1 L/min for a neonate, 1–2 L/min for an infant, 1–4 L/min for an older child) through a nasal catheter or nasal prongs, humidification is not necessary	Strong recommendation ( <i>low-quality evidence</i> )
2.	When oxygen is delivered at a higher-than-standard flow rate (> 4 L/min) through a nasal catheter or nasal prongs, humidification is necessary.	Strong recommendation ( <i>low-quality evidence</i> )

### 6.2 Unheated bubble humidifiers

An unheated bubble humidifier is a simple device that adds little to the cost of oxygen equipment, but because it is inefficient, its role is limited. Unheated bubble humidifiers can be used when oxygen is delivered by cylinders through a nasal catheter, if a nasopharyngeal catheter is used to deliver oxygen or if a higher-than-standard flow is used.

Bubble humidifiers (see Fig. 18) reduce the dryness of the oxygen supplied from a cylinder by bubbling the gas through water at room temperature. The bubble humidifier is filled with clean water (distilled water or tap water that has been boiled and cooled), and then the humidifier is firmly attached to the oxygen outlet, taking care to avoid oxygen leaks and making sure that it is bubbling. The water level in the humidifier should be checked twice daily and topped up as necessary. Humidifier equipment must be washed and disinfected regularly to prevent bacterial colonization.

**Fig. 18.** An unheated bubble humidifier connected to a wall bracket

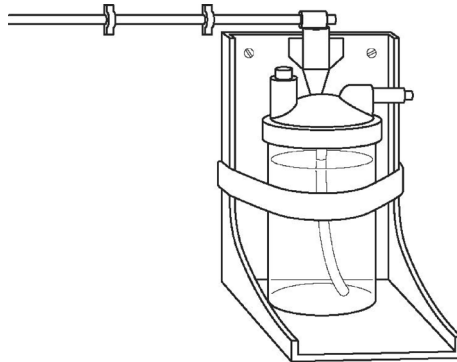

Maintenance of humidifiers is also important. The water should be changed daily, and the humidifier, water jar and catheter should be washed in mild soapy water, rinsed with clean water and dried in air before reuse. Once a week (or whenever a patient ceases oxygen therapy), all the components of the humidifier should be soaked in a mild antiseptic solution for 15 min, rinsed with clean water and dried in air. Allowing the humidifier to dry completely will discourage bacterial colonization. A spare, clean humidifier filled with clean water should always be available, so that oxygen therapy is not interrupted while the humidifier is being cleaned. Unheated humidifiers are moderately effective, even at low flow rates in tropical climates.

Heated humidifiers (Fig. 15) are more effective than unheated ones (54); however, they are moderately expensive and require a continuous power supply. Bubble humidifiers are sufficient for giving basic oxygen therapy at standard flow rates or at higher flow rates when a heated humidifier is not available.

### 6.3 Safety of humidifiers

A major concern with regard to water humidifiers is bacterial contamination. In one study, prefilled disposable reservoirs were found to be pathogen-free for up to 3 days (55), but, in another study, 22 of 30 reservoirs in ambulance humidifiers with multiple-use bottles contained bacteria (56). Humidifiers filled with tap water were not contaminated more frequently than those containing sterile water (57), but this may not be the case in all settings; in some hospitals, tap water may be contaminated and increase the risk for hospital-acquired (nosocomial) infection.



## 6.4 During tracheostomy

Humidification is essential for patients with an endotracheal tube or a tracheostomy. The nose and mouth provide warmth, filtering and moisture for the air we breathe; however, a tracheostomy tube (Fig. 19) bypasses these mechanisms, and humidification must be provided to keep secretions thin and to avoid mucous plugs. Patients who have had a tracheostomy do best in an environment of  $\geq 50\%$  humidity. In patients who are not ventilated, secretions can be kept thin by applying a heat moisture exchanger (sometimes called a “Swedish nose”) to the tracheostomy tube (shown in Fig. 19). This humidifying filter fits onto the end of the tracheostomy tube; several shapes and sizes are available, but all styles fit over the standard tracheostomy tube opening.

**Fig. 19. Child with tracheostomy tube and diagram of a heat moisture exchanger connected to the tracheostomy tube**

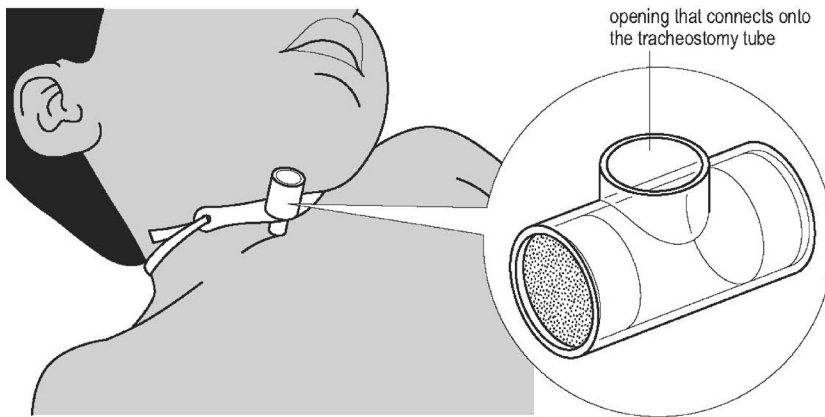

In patients with a tracheostomy or an endotracheal tube who are receiving supplemental oxygen or CPAP, heated humidifiers are preferred to unheated humidifiers.

### KEY MESSAGES

- Humidification is necessary only when oxygen is delivered by methods that bypass the nose or high flow rates are used. It is generally not necessary when oxygen is delivered through a nasal catheter or nasal prongs at standard flow rates.
- Humidification is essential when cold oxygen is delivered from a cylinder through a nasopharyngeal catheter.
- Humidifier reservoirs should be cleaned regularly to avoid bacterial contamination.
- Humidification is essential for patients with an endotracheal tube or a tracheostomy. Endotracheal tube obstruction due to inadequate humidification is the cause of many unnecessary deaths in hospitals.

---

## 7. Monitoring the progress of children on oxygen

In most hospitals, the most appropriate way to monitor children is by regular (at least twice a day) pulse oximetry to determine whether they need oxygen and whether those who are already on oxygen have developed respiratory distress or show other clinical signs of deterioration. Pulse oximetry can also be used to determine how long children should receive oxygen. In severe pneumonia, hypoxaemia can last from several hours to several weeks; the usual duration is 2–5 days (14, 58). Hypoxaemia may last longer at higher altitudes than at sea level for pneumonia of similar severity (35). For children in a stable condition and with  $\text{SpO}_2 > 90\%$ , oxygen should be interrupted once a day to determine whether they still require it (see [section 7.1](#)).

As pulse oximeters provide no information on the carbon dioxide concentration in blood, they provide no direct information on ventilatory efficiency. It is unlikely that a child who has normal oxygen saturation while breathing room air has impaired ventilation; however, once oxygen is administered,  $\text{SpO}_2$  can be maintained at normal levels despite severe hypercapnoea. As pulse oximetry cannot indicate the adequacy of ventilation in children receiving oxygen, clinical monitoring of respiratory effort, respiratory rate and consciousness level is a guide to the adequacy of ventilation. A child with inadequate ventilation will have slow or shallow breathing and be lethargic.

In a small hospital, any concern about the adequacy of ventilation should prompt efforts to ensure that the airway is clear and protected and that the patient is positioned to facilitate chest expansion (e.g. sitting in a semi-recumbent position at 20–30°, head up to reduce diaphragmatic splinting if there is abdominal distension, passing a nasogastric tube to deflate the stomach). Referral to a high-dependency area or intensive care unit should be arranged if CPAP or mechanical support is available.

Oxygen administration by any method must be supervised by trained personnel to detect and manage complications appropriately. A nurse should check every 3 h that the prongs or catheter are in the correct position and not blocked with mucus, that all connections are secure, that the oxygen flow rate is correct, that the airways are not obstructed by mucus and that there is no gastric distension. Prongs or catheters should be removed and cleaned at least twice a day.

All severely ill children must be monitored regularly for vital signs and general condition. Many deaths in hospitals occur overnight, often when monitoring is infrequent or absent (59). As  $\text{SpO}_2$  is the most vital clinical sign, pulse oximetry is an invaluable routine monitoring tool.

For more details on monitoring, see below and [annexes 1 and 2](#).

## CRITERIA FOR STARTING AND STOPPING OXYGEN THERAPY

	RECOMMENDATIONS	QUALITY OF EVIDENCE
1.	Children with hypoxaemia should be closely monitored by pulse oximetry.	Strong recommendation ( <i>very low-quality evidence</i> )
2.	Oxygen therapy should be discontinued in a clinically stable child when oxygen saturation remains stable above the recommended level of 90% at $\leq 2500$ m above sea level or 87% at $> 2500$ m above sea level for at least 15 min on room air.	Strong recommendation ( <i>very low-quality evidence</i> )

### 7.1 When to stop oxygen

At least once each day, children who are clinically stable (have no emergency signs and  $SpO_2 > 90\%$ ) should be disconnected from oxygen for 10–15 min and carefully examined for changes in clinical signs and  $SpO_2$ , to assess whether supplemental oxygen is still required. Supplemental oxygen is best interrupted first thing in the morning, when there are likely to be adequate staff to observe the child throughout the day. If supplemental oxygen is discontinued in the late afternoon, the presence of few overnight staff and the oxygen desaturation that sometimes occurs during sleep might increase the risk for unrecognized hypoxaemia during the night.

Children who have an  $SpO_2 < 90\%$  while still on oxygen or who are unstable or very unwell should not be given trials on room air. Before a trial of discontinuing oxygen, the  $SpO_2$  should be checked to determine whether such a trial is safe (i.e.  $SpO_2 > 90\%$ ).

The child should then be disconnected from the oxygen source and observed carefully to avoid any adverse complications of hypoxaemia. If severe hypoxaemia ( $SpO_2 < 80\%$ ), apnoea or severe respiratory distress occurs, the child should be immediately restarted on oxygen. Some children will become hypoxaemic very rapidly when they are taken off oxygen; this is a marker of very severe disease and a high risk for death. Parents and nursing staff should be advised to watch children to determine whether they develop cyanosis or severe respiratory distress.

Where oxygen supplies are ample, children should receive supplemental oxygen until their  $SpO_2$  on room air is  $\geq 90\%$ . If the  $SpO_2$  is  $\geq 90\%$  after a trial on room air, they should remain off oxygen, and the  $SpO_2$  should be rechecked after 1 h, as late desaturation can sometimes occur.

For all children who appear to deteriorate clinically, the  $SpO_2$  should be checked to determine whether they need oxygen. If bed space allows, children should not be discharged until their  $SpO_2$  has been stable at  $\geq 90\%$  while breathing room air for at least 24 h, until all danger signs have resolved and appropriate home treatment can be organized. This of course does not apply to children with cyanotic congenital heart disease who have chronic hypoxaemia. For children with right-to-left intracardiac shunt (such as tetralogy of Fallot), oxygen will not be effective in relieving cyanosis or improving  $SpO_2$ .

The chest X-ray appearance is not a useful guide to the need for oxygen therapy or to when it is appropriate to stop oxygen.

## 7.2 General care of children with hypoxaemia or severe respiratory distress

Nursing care of children with hypoxaemia is very important. The main considerations include minimal handling, positioning, fluids, nutrition and close monitoring.

Handling can be upsetting to severely ill children, and any activity consumes more oxygen. Handling should be gentle, and unnecessary stress or painful procedures should be avoided.

Children will often find their own most comfortable position in bed or on their mother's lap, but sometimes their breathing may improve if they are nursed with their head raised about 30° with neck support, rather than lying flat. Some hypoxic neonates and young infants may be more stable in the prone position, as long as their faces are not obstructed.

The following guidelines should be followed when providing fluids and nutrition to hypoxaemic children.

- Withhold oral feeds while the child has severe chest indrawing or severe respiratory distress to avoid the risk for aspiration.
- Use an intravenous drip or a nasogastric tube, depending on which is safest.
- **Do not give large volumes of intravenous fluids**, as they may make the lungs “wet” and worsen hypoxaemia. The maximum rate of intravenous fluid administration required is usually 2–3 mL/kg body weight per hour and should be stopped once oral or nasogastric tube feeds are tolerated.
- If nasogastric tube feeds are given use small volumes, and ensure that the nasogastric tube is well in the stomach. Do not give large nasogastric feeds to children with severe respiratory distress, as they may vomit and aspirate.
- As soon as severe respiratory distress has resolved, make sure that the child receives good nutrition, preferably breast milk.

### *Overcoming parents' concerns about oxygen use*

Parents must be educated about the need for oxygen in order to alleviate their fears. Many parents are afraid of oxygen and oxygen catheters, perhaps because they have seen other children receive oxygen just before they died and may fear that it was the oxygen that caused the death. It can be helpful to show parents the pulse oximeter in operation and explain to them why the child's oxygen level is low. It is also useful to show them the clinical signs (such as chest indrawing or cyanosis of the gums or tongue); when oxygen is given, the parents will see that the SpO<sub>2</sub> increases and the child's respiratory distress lessens. In a hospital in Papua New Guinea, the rate of mothers who absconded with their children fell significantly, from about 25% to 8%, when children were checked daily by pulse oximetry (14, 50), with an explanation of monitoring and its implications for oxygen delivery, having to stay in hospital and readiness for discharge. The pulse oximetry checks were also considered a daily demonstration that special attention was being paid to the child, which the mothers appreciated. Even illiterate mothers could understand the significance of the number

on the pulse oximeter and the threshold for safe discharge when this was explained to them.

### KEY MESSAGES

- Children receiving oxygen should be monitored clinically at least twice a day by pulse oximetry.
- A nurse should check every 3 h that the prongs or catheter are in the correct position and not blocked with mucus, that all connections are secure, that the oxygen flow rate is correct, that the airways are not obstructed by mucus and that there is no gastric distension. Prongs or catheters should be removed and cleaned at least twice a day.
- SpO<sub>2</sub> is the most critical vital sign; therefore, pulse oximetry is an invaluable routine monitoring tool.
- In severe pneumonia, hypoxaemia may last from several hours to several weeks; the usual duration is 2–5 days.
- At least once a day, children who are clinically stable (have no emergency signs and SpO<sub>2</sub> > 90%) should be disconnected from oxygen for 10–15 min and carefully examined for changes in clinical signs and SpO<sub>2</sub>, to determine whether supplemental oxygen is still required.
- Children should not be discharged until their SpO<sub>2</sub> has been stable at ≥ 90% while breathing room air for at least 24 h, until all danger signs have resolved and until appropriate home treatment has been organized.

---

# References

1. United Nations Inter-agency Group for Child Mortality Estimation. Levels and trends in child mortality. Report 2015. New York: United Nations Children's Fund; 2015.
2. Walker CL, Rudan I, Liu L, Nair H, Theodoratou E, Bhutta ZA, et al. Global burden of childhood pneumonia and diarrhoea. *Lancet* 2013;381:1405–1416.
3. Subhi R, Adamson M, Campbell H, Weber M, Smith K, Duke T, et al. The prevalence of hypoxaemia among ill children in developing countries. *Lancet Infect Dis* 2009;9:219–227.
4. Duke T, Wandu F, Jonathan M, Matai S, Kaupa M, Sa'avu M, et al. Improved oxygen systems for childhood pneumonia: a multihospital effectiveness study in Papua New Guinea. *Lancet* 2008;372:1328–1333.
5. Subhi R, Smith K, Duke T. When should oxygen be given to children at high altitude? A systematic review to define altitude-specific hypoxaemia. *Arch Dis Child* 2009; 94:6–10.
6. Laman M, Ripa P, Vince J, Tefuarani N. Can clinical signs predict hypoxaemia in Papua New Guinean children with moderate and severe pneumonia? *Ann Trop Paediatr* 2005;25:23–27.
7. Duke T, Blaschke AJ, Sialis S, Bonkowsky JL. Hypoxaemia in acute respiratory and non respiratory illness in neonates and children in a developing country. *Arch Dis Child* 2002;86:108–112.
8. Duke T. Neonatal pneumonia in developing countries. *Arch Dis Child Fetal Neonatal Ed* 2005;90:211–219.
9. Rahnema'i MS, Geilen RP, Singhi S, van den Akker M, Chavannes NH. Which clinical signs and symptoms predict hypoxemia in acute childhood asthma? *Indian J Pediatr* 2006;73:771–775.
10. Muhe L, Weber M. Oxygen delivery to children with hypoxaemia in small hospitals in developing countries. *Int J Tuberc Lung Dis* 2001;5:527–532.
11. Zavorsky GS, Cao J, Mayo NE, Gabbay R, Murias JM. Arterial versus capillary blood gases: a meta-analysis. *Resp Physiol Neurobiol* 2007;155:268–279.
12. Rojas MX, Granados Rugeles C, Charry-Anzola LP. Oxygen therapy for lower respiratory tract infections in children between 3 months and 15 years of age. *Cochrane Database Syst Rev* 2009;CD005975.
13. Ayieko P, English M. In children aged 2–59 months with pneumonia, which clinical signs best predict hypoxaemia? *J Trop Paediatr* 2006; 52:307–310.

14. Duke T, Frank D, Mgone J. Hypoxaemia in children with severe pneumonia in Papua New Guinea. *Int J Tuberc Lung Dis* 2000;5:511–519.
15. Onyango FE, Steinhoff MC, Wafula EM, Wariua S, Musia J, Kitonyi J. Hypoxaemia in young Kenyan children with acute lower respiratory infection. *BMJ* 1993;306:612–615.
16. O’Dempsey TJ, Todd JE. Chest infections in African children. *BMJ* 1993;306:1342.
17. Falade AG, Tschappeler H, Greenwood BM, Mulholland EK. Use of simple clinical signs to predict pneumonia in young Gambian children: the influence of malnutrition. *Bull World Health Organ* 1995;73:299–304.
18. Lozano JM, Steinhoff M, Ruiz JG, Mesa ML, Martinez N, Dussan B. Clinical predictors of acute radiological pneumonia and hypoxaemia at high altitude. *Arch Dis Child* 1994;71:323–327.
19. Reuland DS, Steinhoff MC, Gilman RH, Bara M, Olivares EG, Jabra A, et al. Prevalence and prediction of hypoxaemia in children with respiratory infections in the Peruvian Andes. *J Pediatr* 1991;119:900–906.
20. O’Dempsey TJ, McArdle TF, Laurence BE, Lamont AC, Todd JE, Greenwood BM. Overlap in the clinical features of pneumonia and malaria in African children. *Trans R Soc Trop Med Hyg* 1993;87:662–665.
21. Simoes EA, Roark R, Berman S, Esler LL, Murphy J. Respiratory rate: measurement of variability over time and accuracy at different counting periods. [Comment]. *Arch Dis Childh* 1991;66:1199–1203.
22. Weber MW, Usen S, Palmer A, Shabbar J, Mulholland EK. Predictors of hypoxaemia in hospital admissions with acute lower respiratory tract infection in a developing country. *Arch Dis Child* 1997;76:310–314.
23. Rajesh VT, Singhi S, Kataria S. Tachypnoea is a good predictor of hypoxia in acutely ill infants under 2 months. *Arch Dis Childh* 2000;82:46–49.
24. Usen S, Weber M, Mulholland K, Jaffar S, Oparaugo A, Adegbola R, et al. Clinical predictors of hypoxaemia in Gambian children with acute lower respiratory tract infection: prospective cohort study. *BMJ* 1999;318:86–91.
25. Smyth A, Carty H, Hart CA. Clinical predictors of hypoxaemia in children with pneumonia. *Ann Trop Paediatr* 1988;18:31–40.
26. Schnapp L. Uses and abuses of pulse oximetry. *Chest* 1990;98:1244–1250.
27. Weber MW, Mulholland EK. Pulse oximetry in developing countries. *Lancet* 1998; 351:1589.
28. Pocket book of hospital care for children: guidelines for the management of common childhood illnesses. 2nd edition. Geneva: World Health Organization; 2013.
29. Malkin RA. Design of healthcare technology for the developing world. *Annu Rev Biomed Eng* 2007;9:567–587.

30. Frey B, Shann F. Oxygen administration in infants. *Arch Dis Child Fetal Neonatal* Ed 2003;88:F84–F88.
31. Frey B, McQuillan PJ, Shann F, Freezer N. Nasopharyngeal oxygen therapy produces positive end-expiratory pressure in infants. *Eur J Pediatr* 2001;160:556–560.
32. Sreenan C, Lemke RP, Hudson-Mason A, Osiovich H. High-flow nasal cannulae in the management of apnea of prematurity: a comparison with conventional nasal continuous positive airway pressure. *Pediatrics* 2001;107:1081–1083.
33. Muhe L, Degefu H, Worku B, Oljira B, Mulholland EK. Comparison of nasal prongs with nasal catheters in the delivery of oxygen to children with hypoxia. *J Trop Pediatr* 1998;44:365–368.
34. Campbell EJ, Baker D, Crites-Silver P. Subjective effects of humidification of oxygen for delivery by nasal cannula. *Chest* 1988;93:289–293.
35. Weber MW, Palmer A, Oparaugo A, Mulholland EK. Comparison of nasal prongs and nasopharyngeal catheter for the delivery of oxygen in children with hypoxaemia because of lower respiratory tract infection. *J Pediatr* 1995;127:378–383.
36. Kuluz JW, McLaughlin GE, Gelman B, Cantwell P, Thomas J, Mahon T, et al. The fraction of inspired oxygen in infants receiving oxygen via nasal cannula often exceeds safe levels. *Respir Care* 2001;46:897–901.
37. Shann F, Gatchalian S, Hutchinson R. Nasopharyngeal oxygen in children. *Lancet* 1988;ii:1238–1240.
38. Muhe L, Degefu H, Worku B, Oljira B, Mulholland EK. Oxygen administration to hypoxic children in Ethiopia: a randomized controlled study comparing complications in the use of nasal prongs with nasopharyngeal catheters. *Ann Trop Paediatr* 1997;17:273–281.
39. Klein M, Reynolds LG. Nasopharyngeal oxygen in children. *Lancet* 1989;i:493–494.
40. Daga SR, Vesma B, Gosavi DV. Oropharyngeal delivery of oxygen to children. *Trop Doct* 1999;29:98–99.
41. SUPPORT Study Group of the Eunice Kennedy Shriver NICHD Neonatal Research Network. Target ranges of oxygen saturation in extremely preterm infants. *N Engl J Med* 2010;362:1959–1969.
42. Yee W, Chen SY, Singhal N. Oxygen saturation trends immediately after birth. *J Pediatr* 2006;148:590–594.
43. Kattwinkel J, Niermeyer S, Nadkarni V, Tibballs J, Phillips B, Zideman D, et al. ILCOR advisory statement: resuscitation of the newly born infant. *Pediatrics* 1999;103:e56.



44. Wilson PT, Morris MC, Biagas KV, Otopiri E, Moresky RT. A randomized clinical trial evaluating nasal continuous positive airway pressure for acute respiratory distress in a developing country. *J Pediatr* 2013;162:988–992
45. Duke T. CPAP: a guide for clinicians in developing countries. *Paediatr Int Child Health* 2014;34:3–11.
46. Martin S, Duke T, Davis P. Efficacy and safety of bubble CPAP in neonatal care in low and middle income countries: a systematic review. *Arch Dis Child Fetal Neonatal Ed* 2014;99:495–504.
47. van den Heuvel M, Blencowe H, Mittermayer K, Rylance S, Couperus A, Heikens GT et al. Introduction of bubble CPAP in a teaching hospital in Malawi. *Ann Trop Paediatr* 2012; 31:59–65.
48. Chisti MJ, Salam MA, Smith JH, Ahmed T, Pietroni MC, Shahunja KM, et al. Bubble continuous positive airway pressure for children with severe pneumonia and hypoxaemia in Bangladesh: an open, randomised controlled trial. *Lancet* 2015;386:1057–1065.
49. Tagare A, Kadam S, Vaidya U, Pandit A, Patole S. Bubble CPAP versus ventilator CPAP in preterm neonates with early onset respiratory distress – a randomised controlled trial. *J Trop Paediatr* 2013; 59:113–119.
50. McKiernan C, Chua LC, Visintainer PF, Allen H. High flow nasal cannulae therapy in infants with bronchiolitis. *J Pediatr* 2010;156:634–638.
51. Spentzas T, Minarik M, Patters AB, Vinson B, Stidham G. Children with respiratory distress treated with high-flow nasal cannula. *J Intensive Care* 2009; 24:323–328.
52. Hilliard TN, Archer N, Laura H, Heraghty J, Cottis H, Mills K, et al. Pilot study of vapotherm oxygen delivery in moderately severe bronchiolitis. *Arch Dis Childh* 2011;97:183.
53. Lampland AL, Plumm B, Meyers PA, Worwa CT, Mammel MC. Observational study of humidified high-flow nasal cannula compared with nasal continuous positive airway pressure. *J Pediatr* 2009;154:177–182.
54. Randerath WJ, Meier J, Genger H, Domanski U, Rühle KH. Efficiency of cold passover and heated humidification under continuous positive airway pressure. *Eur Respir J* 2002;20:183–186.
55. Koss JA, Conine TA, Eitzen HE, LoSasso AM. Bacterial contamination potential of sterile, prefilled humidifiers and nebulizer reservoirs. *Heart Lung* 1979;8:1117–1121.
56. Cameron JL, Reese WA, Tayal VS, Clark RF, Kelso D, Gonzalez ER, et al. Bacterial contamination of ambulance oxygen humidifier water reservoirs: a potential source of pulmonary infection. *Ann Emerg Med* 1986;15:1300–1302.
57. Cahill CK1, Heath J. Sterile water used for humidification in low-flow oxygen therapy: is it necessary? *Am J Infect Control* 1990;18:13–17.

58. Duke T, Poka H, Frank D, Michael A, Mgone J, Wal T. Chloramphenicol versus benzylpenicillin and gentamicin for the treatment of severe pneumonia in children in Papua New Guinea: a randomised trial. *Lancet* 2002;359:474–480.
59. Nolan T, Angos P, Cunha AJ, Muhe L, Qazi S, Simoes EA, et al. Quality of hospital care for seriously ill children in less-developed countries *Lancet* 200;357:106–110.

---

# ANNEX 1

## Practical use of pulse oximetry in children's wards

A pulse oximeter can provide vital information about a sick child. It is the best instrument for determining whether a child needs oxygen, although clinical signs of hypoxaemia and severe illness should also be sought.

### A1.1 When to use a pulse oximeter

Pulse oximeters should be used to monitor:

- all children at the time of admission (not just those with pneumonia);
- the progress of children during ward rounds and nursing observations; and
- any child who deteriorates, with respiratory distress, apnoea or decreased consciousness.

### A1.2 Using a pulse oximeter

1. Turn the pulse oximeter on.
2. Ensure that the child is sitting comfortably on the parent's lap.
3. Attach the pulse oximeter probe to the child's finger or toe.
4. Wait until there is a consistent pulse signal (this may take 20–30 s).
5. Record the SpO<sub>2</sub> and pulse rate on a monitoring chart.
6. If you are uncertain whether the SpO<sub>2</sub> and pulse is being accurately detected, check the heart rate with a stethoscope or manually feel the pulse.
7. If the SpO<sub>2</sub> is < 90%, give the child oxygen,
  - through nasal prongs or a nasal catheter and
  - at a flow rate of 0.5–2 L/min continuously.
8. Recheck the SpO<sub>2</sub>.
9. Record the SpO<sub>2</sub> and pulse rate on a monitoring chart 15 min after giving oxygen.

### A1.3 Daily monitoring

At least once a day, all children who are receiving oxygen should be tested by pulse oximetry.

1. Take the child off oxygen (unless he or she has severe respiratory distress).
2. Monitor the SpO<sub>2</sub>.
3. If the SpO<sub>2</sub> is > 90% 10–15 min after the child has been taken off oxygen, leave the oxygen off.
4. Check the SpO<sub>2</sub> again in 1 h.
5. If the SpO<sub>2</sub> is < 90%, resume oxygen.
6. Each day, record the SpO<sub>2</sub> and pulse rate on the patient's monitoring chart, and record beside it whether there is a sufficient supply of oxygen.

7. Use pulse oximetry regularly to monitor all children who show worsening respiratory distress, apnoea, any deterioration in consciousness or any other clinical sign of deterioration.

#### **A1.4 Planning discharge**

Pulse oximetry can be used to determine when it is safe to send a child home. In most circumstances, it is not safe to send children home when their  $\text{SpO}_2$  is  $< 90\%$ . However you don't need to wait until their  $\text{SpO}_2$  is normal to discharge them. If the child is well, and the  $\text{SpO}_2$  has been stably  $> 90\%$  off oxygen for 12–24 h, and the parents understand how to provide home care and when to return, it is safe to send the child home.

#### **A1.5 Care of a pulse oximeter**

The pulse oximeter finger probes and leads are fragile; therefore, it is important to look after them carefully. They should not be put on the floor where they could be stepped on.

It is important to keep pulse oximeter probes clean so that they do not spread infection from one patient to another. They should be wiped with an alcohol swab between patients. Health workers must always wash their hands before and after monitoring each patient.

Always remember to plug the pulse oximeter into the mains power at regular intervals to recharge the internal battery.

---

## ANNEX 2

### Administration of oxygen with oxygen concentrators

#### A2.1 Oxygen concentrators

Oxygen concentrators are machines that extract nitrogen from atmospheric air, resulting in an output of almost pure oxygen. They require a continuous, reliable power source, such as mains electricity plus a back-up generator or oxygen cylinder in case of power failure.

#### A2.2 Using an oxygen concentrator

1. Position the concentrator so that it is at least 30 cm away from walls or curtains, so that the inlet at the back is not obstructed.
2. Connect oxygen tubing to the flow splitter or oxygen outlet.
3. Plug the power cord into the mains electricity supply.
4. Turn on the concentrator (switch on the console). A green light should come on when a sufficiently high oxygen concentration is reached, usually within 10 min.
5. Adjust the flow meter to the flow required for the patient or, if using a flow splitter, the number of patients receiving oxygen.

#### A2.3 Routine maintenance

An oxygen concentrator will require approximately 30 min of attention each week. Concentrators have a large particulate filter over the air inlet (usually at the back of freestanding or portable models) to stop dust and other airborne particles from entering the unit. The filter should be removed and cleaned in warm soapy water, dried with an absorbent towel and replaced.

The exterior of the oxygen concentrator should be cleaned with a mild disinfecting cleaning agent or a diluted solution of bleach (5.25% sodium hypochlorite). A solution of 1:100 to 1:10 of bleach to water can be used, depending on the amount of organic material present. Allow the solution to remain on the surface for 10 min, and then rinse off and dry.

#### A2.4 Giving oxygen

Oxygen is usually given through a nasal catheter or nasal prongs.

##### *Nasal catheter*

A 6-F or 8-F catheter is passed for a distance equal to the distance from the side of the nostril to the inner margin of the eyebrow (see [Fig. A2.1](#)). This usually reaches the back of the nasal cavity. Set a flow rate of 0.5 L/min for neonates or 1–2 L/min for infants and older children. Humidification is not required with a nasal catheter

if these flow rates are used. If an oxygen catheter is not available, a nasogastric tube with the end cut off is sufficient (and cheaper).

Catheters should be removed and cleaned twice a day, as they can become blocked with mucus.

### *Nasal prongs*

In hospitals in which nasal prongs are available, they should be placed just inside the nostrils and secured in place with tape, as shown in [Fig. A2.2](#). Set a flow rate of 0.5–1 L/min for neonates, 1–2 L/min for infants and older children and up to a maximum of 4 L/min for preschool and school-aged children. Humidification is not required with nasal prongs as long as these flow rates are used.

Oxygen prongs are more expensive than oxygen catheters, but they can be reused if they are carefully soaked in clean, warm soapy water, followed by dilute bleach, rinsing in water and careful drying.

## **A2.5 Monitoring**

After starting a child on oxygen, recheck the oxygen saturation with a pulse oximeter or check for signs of hypoxaemia.

If, after starting on oxygen, the child still has an  $SpO_2 < 90\%$  or has cyanosis or severe chest indrawing, increase the oxygen flow to a maximum of 2 L/min for an infant or up to 4 L/min for an older child. If, despite this, the child still has signs of hypoxaemia, check that:

- the concentrator is delivering a flow of gas;
- the light indicating an adequate concentration of oxygen is on and that no other alarms are on;
- oxygen is flowing from the catheter or prongs (put the end under water in a beaker and watch for bubbles, or hold the end close to your hand to feel the airflow);
- there are no leaks in the connections or the oxygen tubing; and
- the child's nose is not blocked.



*Fig. A2.1. Nasal catheter in place*



*Fig. A2.2. Nasal prongs*

Do not use flow rates  $> 2$  L/min for neonates or infants, as they can result in distension of the stomach. Any infant who is unable to suck or who needs an oxygen flow of 2 L/min should have a nasogastric tube to decompress the stomach.

If the  $SpO_2$  remains  $< 90\%$  or signs of hypoxaemia persist, the child may need a second source of oxygen, such as high-flow mask oxygen, if it is available. Consult your hospital engineer to check the functioning of the concentrator.

### **A2.6 Oxygen can spread fire very rapidly**

It is very important not to allow an open flame or a cigarette anywhere within 3 m of an oxygen source. Post “No smoking” signs wherever oxygen is used.

---

## ANNEX 3

### Administration of oxygen from oxygen cylinders

#### A3.1 Oxygen cylinders

Cylinders contain compressed gaseous oxygen. They must have a regulator to limit the pressure of oxygen being released, a gauge to indicate the amount of oxygen in the cylinder and a flow meter to control oxygen flow to the patient.

When using an oxygen cylinder:

- Tighten all the connections (between the cylinder and the regulator and between the regulator and the flow meter), so that oxygen does not leak out.
- Open the regulator, and check the amount of oxygen in the cylinder on the pressure gauge. If the needle of the gauge is in the red zone, the cylinder is nearly empty and should not be used, unless it is the only one you have. *Never* allow such a cylinder to be used for a child overnight, as it will run out and the child will become hypoxaemic.

#### A3.2 Giving oxygen

Oxygen is usually given by nasal catheter or nasal prongs (see Annex 2).

#### A3.3 Monitoring

After starting a child on oxygen, recheck the oxygen saturation with a pulse oximeter and/or check for signs of hypoxaemia. If the child still has an  $SpO_2 < 90\%$  or has cyanosis or severe chest indrawing, increase the oxygen flow to a maximum of 2 L/min for an infant or up to 4 L/min for an older child. If, despite this, the child still has signs of hypoxaemia, check that:

- the cylinder has sufficient oxygen;
- oxygen is flowing from the catheter or prongs (put the end under water in a beaker and look for bubbles, or hold the end close to your hand to feel the airflow);
- there are no leaks in the connections or the oxygen tubing; and
- the child's nose is not blocked.

Do not use flow rates  $> 2$  L/min for neonates or infants, as they can result in distension of the stomach. Any infant who is unable to suck or who needs an oxygen flow of 2 L/min should have a nasogastric tube to decompress the stomach. If the  $SpO_2$  remains  $< 88\%$  or signs of hypoxaemia persist, the child may need a second source of oxygen, such as a high-flow mask, if it is available.



### **A3.4 Supply of oxygen cylinders**

It is important to monitor the amount of oxygen in the cylinder. If the needle is in the red zone, the bottle will have to be changed soon. *Never* allow such a cylinder to be used for a child overnight, as it will run out and the child will become hypoxaemic.

You must anticipate the need for oxygen and order more before it runs out.

### **A3.5 Oxygen can spread fire very rapidly**

It is very important not to allow an open flame or a cigarette anywhere within 3 m of an oxygen source. Post “No smoking” signs wherever oxygen is used. Firebreak connectors are recommended to stop the oxygen flow in the event of fire.

**For more information, please contact:**

**Department of Maternal, Newborn, Child and Adolescent Health  
World Health Organization  
Avenue Appia 20, CH-1211 Geneva 27, Switzerland  
Fax: +41 22 791 4853  
E-mail: [mnach@who.int](mailto:mnach@who.int)  
[www.who.int/](http://www.who.int/)**



**World Health  
Organization**

**ISBN 978 92 4 154955 4**

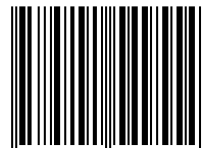

9 789241 549554