



Infection Prevention

A reference booklet for health care providers

ENGENDERHEALTH

Infection Prevention

**A reference booklet for
health care providers**

ENGENDERHEALTH

Publisher's note: Since the publication of this reference booklet, the steps of the "safe handling of sharps" (page 21) have been revised. This PDF version of the booklet contains the revised text.

©2001 EngenderHealth
440 Ninth Avenue
New York, NY, USA
phone: 212-561-8000
fax: 212-561-8067
e-mail: info@engenderhealth.org
www.engenderhealth.org

EngenderHealth works worldwide to improve the lives of individuals by making reproductive health services safe, available, and sustainable. We provide technical assistance, training, and information, with a focus on practical solutions that improve services where resources are scarce. We believe that individuals have the right to make informed decisions about their reproductive health and to receive care that meets their needs. We work in partnership with governments, institutions, and health care professionals to make this right a reality.

EngenderHealth was known as AVSC International until March 2001.

This publication was made possible by a grant from the Bill & Melinda Gates Foundation.

Printed in the United States of America. Printed on recycled paper.

The Library of Congress has catalogued the previous edition of this work as follows:

Infection prevention: a reference booklet for health care providers.

p. cm.

Includes bibliographical references.

ISBN 1-885063-23-7

1. Nosocomial infections--Prevention. 2. Cross infection--Prevention. 3. Medical personnel--Health and hygiene. I. AVSC International.

[DNLM: 1. Infection Control--methods. WX 167 I43 2000]

RA969.I4858 2000

616.4'4--dc21

DNLM/DLC

for Library of Congress

99-32711
CIP

Contents

	page
Foreword	v
Acknowledgments	vi
Introduction	1
Importance of good infection prevention practices	1
How are infections transmitted?	2
Who is at risk of infection?	3
Stopping transmission of infections	4
Handwashing	5
Appropriate times for staff to wash hands	5
Three kinds of handwashing	5
Gloves	7
Three kinds of gloves	7
Aseptic Technique	8
Barriers: Surgical attire	8
Surgical scrub	9
Surgical gloves	11
Client prep	14
Establishing and maintaining a sterile field	18
Good surgical technique	18
Use of prophylactic antibiotics	19
Creating a safer surgical/procedure area	19
Use and Disposal of Sharps	20
Giving injections	20
IV fluids and multidose vials	20
Safe handling of sharps	21
Disposal and decontamination of sharps	21
Management of injuries	23
Instrument Processing	25
The steps of processing	25
Step 1: Decontamination	25
How to make a 0.5% chlorine solution	26
Steps of decontamination	28
Step 2: Cleaning	29
Steps of cleaning	30
Step 3: Sterilization or HLD	32

Using sterilization	32
1. Steam sterilization (autoclaving)	34
2. Dry-heat sterilization (electric oven)	39
3. Chemical (“cold”) sterilization	40
Special considerations	43
Using high-level disinfection (HLD)	44
1. HLD by boiling	45
2. Chemical HLD	47
3. HLD by steaming	50
Special considerations	52
Step 4: Storage	52
Organizing an area for instrument processing	53

Housekeeping and Waste Disposal **56**

General housekeeping guidelines	56
Cleaning solutions	56
Cleaning procedures for different clinic areas	57
Ineffective practices	60
Handling and disposal of medical waste	61
The three kinds of waste	62
Creating a waste-management plan	63

References 69

Index 73

Foreword

Infectious diseases are constantly in transition. New diseases develop, known diseases become widespread or reemerge, and some diseases are eradicated. Over the past few decades, tuberculosis and cholera, diseases that were once better controlled or occurred rarely, have re-emerged. In addition, HIV and the hepatitis C virus have been newly identified and are a significant cause of illness and death in many parts of the world.

Health care personnel are on the front line of protecting themselves and their clients from infectious diseases. They perform clinical procedures or other activities that can expose themselves and clients to potentially infectious microorganisms. Many of their clients are sick and thus may be more susceptible to infections or have infections that can be transmitted to others.

Fortunately, health care staff can perform safe and simple procedures to minimize risk and the spread of infections. These practices can be integrated at minimal cost into the routine workday at clinics and hospitals around the world.

The contents of this booklet represent EngenderHealth's collaboration with health care organizations from around the globe. Working with our partners, we are committed to offering quality reproductive health services to the women and men of the world.

Amy E. Pollack, M.D., M.P.H.
President

Acknowledgments

The development of this booklet was made possible through a generous grant from the Bill & Melinda Gates Foundation. EngenderHealth would like to thank the foundation for its continued support of our work to provide Web and CD-ROM training to staff in health facilities in the developing world.

The content of this booklet is based upon EngenderHealth's infection prevention training curriculum, CD-ROM, and online course www.engenderhealth.org/ip. EngenderHealth would like to extend special thanks to the health professionals throughout the developing world who have volunteered to test this material and to provide vital feedback that has helped make this booklet better serve the needs of the global health community.

We would also like to thank all the colleagues, EngenderHealth staff members, and consultants who participated in the development and testing of the material on which this booklet is based. In particular, we would like to thank: the staff and colleagues around the world who developed and reviewed the print curriculum, CD-ROM, and online course; those who helped test the print curriculum in Egypt, Ghana, India, and Kyrgyzstan; the staff and colleagues in Nepal, Ghana, and South Africa who participated in the testing of the CD-ROM; and the global health professionals who have helped test both the instructor-led and self-instructional versions of the online course.

In addition, we would like to thank the EngenderHealth team that developed and produced this booklet: Mark Barone (content expert), Cassandra Cook (production manager), Stephanie Greig (design), Pamela Beyer Harper (content reviewer), Anna Kurica (production), Margaret Scanlon (proofreader), and Joanne Tzanis (editor).

Introduction

Without the proper precautions, your health care facility can cause the spread of infections and diseases. When providing health services, it is essential to prevent the transmission of infections at all times.

Importance of good infection prevention practices

Over the past few decades, the world has seen increased outbreaks of disease that were once better controlled, and previously unidentified infectious agents that can cause incurable diseases, such as HIV and hepatitis C, have become a significant cause of illness and death in many parts of the world. In addition, hospital-acquired infections are a continuing problem everywhere in the world. There are many complex reasons for these developments, including:

- Rapid population growth, combined with increased poverty
- Expansion of the population into “remote” areas
- Environmental degradation
- Improved transportation, leading to easier spread of disease
- Inadequate or deteriorating public health infrastructure
- Widespread, and often inappropriate, availability and use of antibiotics
- Poor disease control and disease prevention

Infections in health care settings

Although we do not often think about it, health care facilities are ideal settings for transmission of disease because:

- Invasive procedures, which have the potential to introduce microorganisms into parts of the body where they can cause infections, are performed routinely.
- Service providers and other staff are constantly exposed to potentially infectious materials as part of their work.
- Many of the people seeking health care services are already sick and may be more susceptible to infections.
- Some of the people seeking services have infections that can be transmitted to others.
- Services are sometimes provided to many clients in a limited physical space, often during a short period of time.

With appropriate infection prevention practices, you can:

- Prevent postprocedure infection, including surgical-site infections and pelvic inflammatory disease (PID).
- Provide high-quality, safe services.
- Prevent infections in service providers and other staff.
- Protect the community from infections that originate in health care facilities.

- Prevent the spread of antibiotic-resistant microorganisms.
- Lower the costs of health care services, since prevention is cheaper than treatment.

How are infections transmitted?

Infections are caused by microorganisms, which are tiny organisms that can only be seen under a microscope. If you could look at your environment under a microscope, you would see that microorganisms are everywhere—on your skin, in the air you breathe, and in people, animals, plants, soil, and water.

Some microorganisms are normally present on your skin and in your respiratory, intestinal, and genital tracts. These are called normal flora. Other microorganisms are normally not found on or in the human body and are usually associated with disease. These are known as pathogens. All microorganisms, including normal flora, can cause infection or disease.

Infections are transmitted when normal flora are introduced into an area of the body where they are not normally found or when pathogens are introduced into the body.

Modes of transmission

There are four ways that infections are transmitted:

- **Contact**—Direct transfer of microorganisms through touch (staphylococcus), sexual intercourse (gonorrhea, HIV), fecal/oral transmission (hepatitis A, shigella), or droplets (influenza, TB)
- **Vehicle**—Material that serves as a means of transfer of the microorganisms. This can be food (salmonella), blood (HIV, HBV), water (cholera, shigella), or instruments and other items used during clinical procedures (HBV, HIV, pseudomonas)
- **Airborne**—Some microorganisms can be carried by air currents (measles, TB)
- **Vector**—Invertebrate animals can transmit the microorganisms (mosquito: malaria and yellow fever; flea: plague)

Who is at risk of infection?

Infection prevention is everybody's business. Just as everyone who works at a health care facility is at risk of infection, every health care worker has a role to play in practicing appropriate infection prevention. In order for infection prevention to be effective, each staff member must do his or her part.

Risks to staff

Service providers are at significant risk of infection because they are exposed to potentially infectious blood and other body fluids on a daily basis. Staff who process instruments and other items, clean up after procedures, clean operating theaters and procedure rooms, and dispose of waste are particularly at risk. Client-to-health care worker transmission can occur through exposure to infectious blood and other body fluids:

- When a health care worker's skin is pierced or cut by contaminated needles or sharp instruments
- When fluids are splashed on the mucous membranes of the health care worker (e.g., eyes, nose, or mouth)
- Through broken skin due to cuts, scratches, rashes, acne, chapped skin, or fungal infections

Almost all cases of hepatitis B and HIV transmission to health care workers have occurred through preventable accidents, such as puncture wounds.

Risks to clients

Clients are at risk of postprocedure infection when, for example, service providers do not wash their hands between clients and procedures, when they do not adequately prepare clients before a clinical procedure, and when used instruments and other items are not cleaned and processed correctly.

Note: It is very rare for clients to get a bloodborne infection like HIV from an infected health care worker. Because this risk is so small, in most cases infected health care workers should not be kept from their regular activities based solely on their medical diagnoses.

Risks to the community

The community is also at risk of infection, particularly from inappropriate disposal of medical waste, such as contaminated sharps. Improperly discarded medical waste—including contaminated dressings, tissue, needles, syringes, and scalpel blades—can be found by children or others scavenging in open dumps, or can scatter on the ground where adults and children travel, putting them at risk of injury and infection. In addition,

some infections can be spread by staff to their family members or others in the community. For example, the Ebola virus outbreak in Africa in 1995 was spread throughout communities, in part, because of poor infection prevention practices in health care facilities.

Stopping transmission of infections

As health professionals, we cannot provide health care services without conducting procedures that put clients and staff at some risk of exposure to potentially infectious materials, but we can prevent transmission in many cases. The only way to prevent infections is to stop the transmission of microorganisms.

The best way to prevent infections at a health facility is by following standard precautions. These are a set of recommendations designed to help minimize the risk of exposure to infectious materials by both clients and staff. The chapters in this booklet give detailed explanations of how to apply the standard precautions to your everyday work in a health facility.

Summary of standard precautions:

1. Wash your hands.
2. Wear gloves.
3. Wear eye protection or faceshields.
4. Wear gowns.
5. Prevent injuries with sharps.
6. Correctly process instruments and client-care equipment.
7. Maintain correct environmental cleanliness and waste-disposal practices.
8. Handle, transport, and process used/soiled linens correctly.

Standard precautions should be followed with every client regardless of whether or not you think the client might have an infection. This is important because it is not always possible to tell who is infected with viruses such as HIV and the hepatitis viruses, and often the infected persons themselves do not know that they are infected. It is safer to act as if every client is infected rather than to apply standard precautions to some clients and not others.

Handwashing

For more than 100 years, research has shown that proper handwashing is the most important way to reduce the spread of infections in health care settings.

Appropriate times for staff to wash hands:

- Immediately when arriving at work
- Before and after examining each client
- After touching anything that might be contaminated
- After handling specimens
- Before putting on gloves for clinical procedures
- After removing any type of glove
- After using the toilet or latrine
- Before leaving work

Three kinds of handwashing

1 Routine handwashing with plain soap and running water

This is appropriate in most situations.

Steps of Routine Handwashing

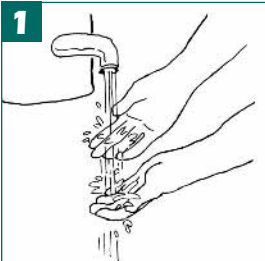

1 Wet hands with running water.

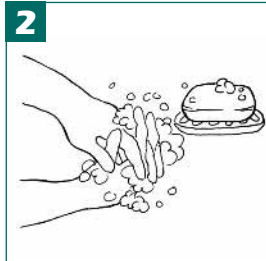

2 Rub hands together with soap and lather well. Make sure to rub all parts of your hands.



3 Vigorously weave fingers and thumbs together and slide them back and forth for 10–15 seconds (longer if hands are visibly soiled).

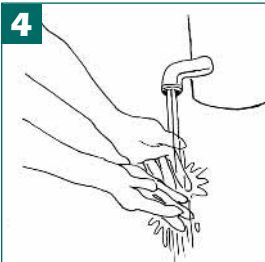

4 Rinse hands under a stream of clean, running water until all soap is gone.

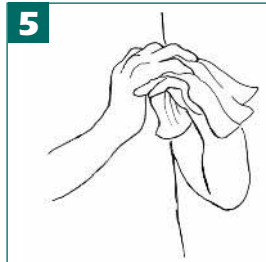

5 Dry hands with a clean towel or allow hands to air-dry.

2 Washing with antiseptics and running water

This is appropriate before invasive procedures (inserting central venous catheter; spinal tap, etc.) and before contact with clients at high risk of infection (newborns, immunosuppressed clients, etc.).

3 An alcohol handrub

This kills or inhibits microorganisms, but does **not** remove microorganisms or soil. Alcohol handrub is used when washing with soap and water is not possible or practical—but only if hands are not visibly dirty.

Because using alcohol alone tends to dry the skin, it is best to use an alcohol handrub solution by adding together 2 mL of glycerine, propylene glycol, or sorbitol and 100 mL of 60–90% alcohol.

To use an alcohol handrub solution: Pour 3–5 mL of an alcohol handrub solution into the palm of your hand and rub hands together until they are dry.

If running water is not available, use:

- A bucket with a tap that can be turned off and on
- A bucket and pitcher (one person pours the water over the other's hands)
- Alcohol handrub, if hands are not dirty



Handwashing Tips:

- Keep bar soap on a rack to allow drainage.
- Always use running water—avoid dipping or washing hands in a basin of standing water.
- Use small bars of soap, or cut large ones into small pieces.
- Always use a clean towel or air-dry your hands.

Gloves

Gloves protect both clients and staff by acting as a barrier against infectious microorganisms. Staff should wear gloves whenever they expect that their hands will come in contact with a client's blood or tissue. Staff should also wear gloves whenever their hands may come in contact with medical waste.

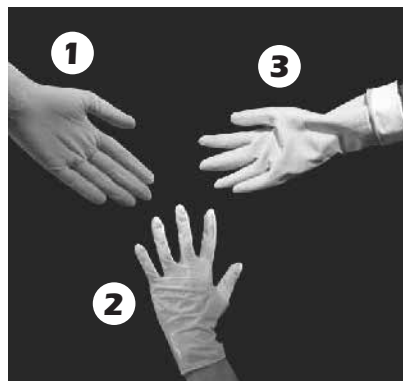

Three kinds of gloves

1 Surgical gloves

These are used when there will be contact with the bloodstream or with tissues under the skin (for example, surgical procedures, pelvic examination for women in labor, etc.).

2 Single-use exam gloves

These are used when there will be contact with intact mucous membranes or where the primary purpose of gloving is to reduce the provider's risk of exposure. These gloves should be thrown out after one use.

3 Utility or heavy-duty household gloves

These are used for handling contaminated items, handling medical or chemical waste, and performing housekeeping activities.

Gloving Tips:

- Always wash utility gloves before you take the gloves off your hands.
- Always wash your hands after removing any type of gloves.
- Never reuse disposable gloves.
- If possible, use disposable surgical gloves, since it is difficult to properly process reusable gloves.

Aseptic Technique

Aseptic technique refers to the practices performed just before or during a clinical or surgical procedure to reduce the client's risk of infection by reducing the likelihood that microorganisms will enter areas of the body where they can cause infection.

Aseptic technique includes:

- Using barriers (surgical attire)
- Surgical scrub and gloving
- Client prep
- Establishing and maintaining a sterile field
- Using good surgical technique
- Creating a safer surgical/procedure area

Barriers: Surgical attire



Gloves prevent microorganisms on the provider's hands from entering the client and protect the provider's hands from contact with blood, other fluids, or tissues.



Masks prevent microorganisms expelled during talking, coughing, or breathing from entering the client and protect the provider's mouth from splashes of blood or other fluids.



Eyecovers and faceshields protect the provider's eyes, nose, and mouth from splashes of blood or other fluids.



Gowns and waterproof aprons prevent microorganisms from the provider's arms, torso, and clothing from entering the client and protect the provider's skin and clothes from splashes of blood and other fluids.



Caps prevent microorganisms from hair and skin on the provider's head from entering the client.



Footwear that is clean and sturdy (closed rubber or leather boots or shoes) helps minimize the number of microorganisms brought into the surgical/procedure area and protects the service provider's feet from injury or splashes of blood and other fluids.

Surgical scrub

Scrubbing reduces the client's risk of infection in case surgical gloves develop holes or tears. Warm, moist conditions inside gloves promote the growth of microorganisms. Performing surgical scrub with an antiseptic before gloving removes or kills many microorganisms, and also helps *prevent* this growth.

Steps of Surgical Scrub



1 & 2
Remove all jewelry on your hands and wrists.

Adjust the water to a warm temperature and wet your hands and forearms thoroughly.



3
Clean under each fingernail with a stick or brush. It is important for all surgical staff to keep their fingernails short.

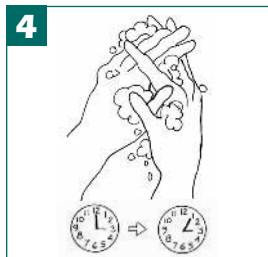

4
Holding your hands up above the level of your elbow, apply the antiseptic. Using a circular motion, begin at the fingertips of one hand and lather and wash between the fingers, continuing from fingertip to elbow. Repeat this for the second hand and arm. Continue washing in this way for 3–5 minutes.

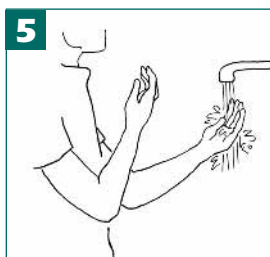

5
Rinse each arm separately, fingertips first, holding your hands above the level of your elbow.



6
Using a sterile towel, dry your hands and arms—from fingertips to elbow—using a different side of the towel on each arm.



7
Keep your hands above the level of your waist and do not touch anything before putting on surgical gloves.

Recent studies have shown that using a brush during surgical scrub provides no greater reduction of microorganisms on the hands than scrubbing with antiseptic alone. Surgical scrub may be performed using either a soft brush or sponge or using an antiseptic alone. Avoid using a hard brush, which is not necessary and may irritate the skin.

Alternative methods of surgical scrub

Although the use of antiseptic for surgical scrub is recommended, an alternative method is necessary when surgical staff members are allergic to the available antiseptic solutions or when antiseptics are not available. Performing surgical scrub with soap and water, followed by an alcohol handrub, can be used in place of antiseptics in these situations. To do this:

Step 1

Perform a surgical scrub with plain soap and warm, running water while following the steps demonstrated on page 9.

Step 2

Apply 3–5 mL of alcohol (or—because using alcohol alone can dry the skin—use an alcohol handrub solution made up of 2 mL glycerine, propylene glycol, or sorbitol mixed with 100 mL of 60–90% alcohol).

Step 3

Rub hands together until they are dry.

Ideally, surgical scrub should be performed before every procedure. However, to prevent skin irritation from too-frequent scrubbing in high-volume settings, use 3–5 mL of an alcohol handrub solution between clients, rubbing your hands together until the alcohol dries. Then scrub every hour or after every four clients, whichever comes first. Note that alcohol handrub does not remove soil or organic material such as blood. If gloves are torn or punctured, or if there is blood or other body fluids on your hands after you remove your gloves, a surgical scrub should be performed.

Surgical Scrub Tips:

- Warm water makes antiseptics work more effectively. Avoid using hot water, which removes protective oils from the skin.
- If you routinely perform surgical procedures, you should keep your fingernails short.
- Always keep your hands above your elbows during and after scrubbing.
- Avoid using a hard brush during scrubbing.
- Always use an antiseptic during surgical scrub. If you are allergic to antiseptics or if an antiseptic is not available, scrub your hands with plain soap, dry them, and use an alcohol handrub.

Surgical gloves

Wear sterile or high-level disinfected* surgical gloves for any procedure where your hands will come in contact with the client's bloodstream or tissues under the skin. It is important to put on and remove the gloves correctly. Gloves become contaminated:

- If you touch the outside of the glove with your bare hand
- If you touch anything that is not sterile or high-level disinfected while wearing the gloves
- If you hold your gloved hands below the level of your waist
- If either glove develops a hole, tear, or puncture

Putting on surgical gloves

Surgical gloves are cuffed to make it easier to put them on without contaminating them. When putting on surgical gloves, remember that the first glove should be picked up by the cuff only. The second glove should then be touched only by the other glove.

Remember that the outside of the glove package is not sterile. If you will open the outer package of gloves yourself, do so before you perform a surgical scrub.

* Sterilization and high-level disinfection are discussed in detail in the Instrument Processing chapter (page 25).

Steps of Putting on Surgical Gloves

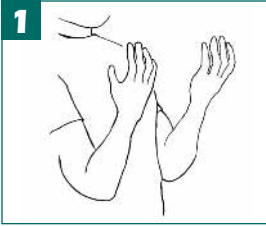

1 Prepare a large, clean, dry area for opening the package of gloves. Either open the outer glove package and then perform a surgical scrub, or perform a surgical scrub and ask someone else to open the package of gloves for you.

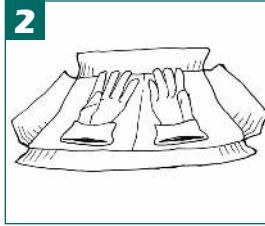

2 Open the inner glove wrapper, exposing the cuffed gloves with the palms up.



3 Pick up the first glove by the cuff, touching only the inside portion of the cuff (the inside is the side that will be touching your skin when the glove is on).

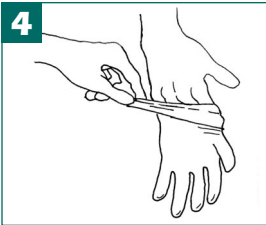

4 While holding the cuff in one hand, slip your other hand into the glove. (Pointing the fingers of the glove toward the floor will keep the fingers open.) Be careful not to touch anything, and hold the gloves above your waist level.



5 Pick up the second glove by sliding the fingers of the gloved hand under the cuff of the second glove. Be careful not to contaminate the gloved hand with the ungloved hand as the second glove is being put on.

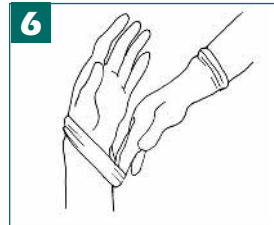

6 Put the second glove on the ungloved hand by maintaining a steady pull through the cuff. Adjust the glove fingers and cuffs until the gloves fit comfortably.

Removing contaminated surgical gloves

As you remove the gloves, do not allow the outside surface of the gloves to come in contact with your skin. Avoid letting the gloves snap, as this may cause contaminants to splash into your eyes or mouth or onto your skin or other people in the area.

Remove used gloves before touching anything: countertops, faucets, and pens and pencils are frequently contaminated because health care workers touch them while wearing used gloves.

Steps of Removing Surgical Gloves

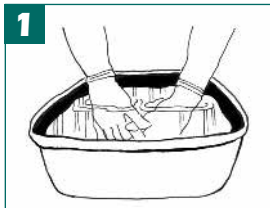

1 Rinse gloved hands in a basin of decontamination solution to remove blood or other body fluids.



2 Grasp one glove near the cuff and pull it partway off. The glove will turn inside out. Keep the first glove partially on before removing the second one to protect you from touching the outside of a glove with your bare hand.



3 Leaving the first glove over your fingers, grasp the second glove near the cuff and pull it partway off. Keep the second glove partially on.

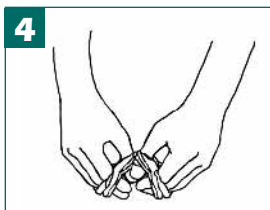

4 Pull off the two gloves at the same time, being careful to touch only the inside surface of the gloves with your bare hand.



5 If the gloves are disposable or are not intact, dispose of them immediately. If they are to be processed for reuse, decontaminate them before processing. Wash hands immediately after gloves are removed, since tiny holes or tears in gloves may leave you at risk of exposure to contaminated fluids.

Surgical Glove Tips:

- The outside of the glove package is not sterile. Either open the outer package before surgical scrub, or have another person open it for you.
- If the gloves become contaminated during a procedure, stop what you are doing, step away from the sterile field, remove the contaminated gloves, and put on new gloves.
- Don't let gloves snap while you are removing them or blood and other matter may splash on you or on those around you.
- During removal, don't allow the outside surface to contact your skin.
- Remove your used gloves before touching anything—including countertops, faucets, pens, and pencils.

Client prep

Proper client prep with antiseptics before a clinical or surgical procedure is critical, since bacteria from a client's skin or mucous membranes can cause infections.

Shaving the surgical/procedure site is no longer recommended because it causes small nicks and breaks in the skin where bacteria can grow and multiply, and it can lead to increased risk of postprocedure infections. Hair around the surgical/procedure site may be clipped very short if it interferes with the procedure. If the site *must* be shaved: 1) use antimicrobial soap and water or shave dry; and 2) shave immediately before the procedure, in the operating theater or procedure room.

To properly prep a surgical/procedure site:

1. Wash the area with soap and water.
2. Apply an antiseptic and gently scrub the skin in a circular motion, beginning in the center of the site and moving out, using sterile cotton balls, cotton wool, or gauze sponges held by a sponge forceps.

For the vagina, cervix, and other mucous membranes: Do not use alcohol or alcohol-based antiseptics on mucous membranes. Using sterile cotton balls, cotton wool, or gauze sponges held by a sponge forceps, apply an antiseptic liberally to the cervix and vagina before instrumentation of the uterus.

About antiseptics

An antiseptic is a chemical agent used to reduce the number of microorganisms on skin and mucous membranes without causing damage or irritation. In addition to removing or killing microorganisms, antiseptics may also prevent the growth and development of some types of microorganisms. Antiseptics are used for:

- Skin, cervical, or vaginal preparation before a clinical procedure
- Surgical scrub
- Handwashing in high-risk situations, such as before an invasive procedure or contact with a client at high risk of infection (e.g., a newborn or immunosuppressed client)

Antiseptics are not meant to be used on inanimate objects, such as instruments and surfaces. Antiseptics are designed to be used for reducing or destroying microorganisms on the skin or mucous membranes without damaging these tissues. They usually do not have the same killing power as chemicals used for disinfection of inanimate objects. Never use antiseptic solutions to disinfect inanimate objects, such as instruments and reusable gloves, and never leave items such as pickup forceps, scissors, scalpel blades, and suture needles soaking in an antiseptic solution.

Common antiseptics used for client prep:

- Iodophors (e.g., Betadine)
- 4% chlorhexidine gluconate (e.g., Hibiclens)
- 1%–3% iodine, followed by 60%–90% alcohol (ethyl or isopropyl)
- Chlorhexidine gluconate with cetrimide (e.g., Savlon)

AVOID using: Hydrogen peroxide (0.3%), which is not appropriate for surgical scrub or client prep; products containing quaternary ammonium compounds, such as benzalkonium chloride (e.g., Zephiran), which are disinfectants and should not be used as antiseptics; or compounds containing mercury (such as mercury laurel), which are highly toxic.

Preventing contamination of antiseptic solutions

Using contaminated solutions can cause infections in clients. Solutions become contaminated when:

- The water used to dilute a solution is contaminated
- Containers in which the solution is placed are contaminated
- Microorganisms from skin or objects contact the solutions during use (such as when removing cotton balls from a solution for use in skin prep)
- The area in which solutions are prepared or used is not clean

Proper handling will reduce the chances of contaminating antiseptic solutions. Pour solutions into smaller containers for use during service delivery to avoid contaminating the stock container. Pour solutions out of the container without touching the rim or the solution itself with your hands, a cotton swab, cloth, or gauze. These can contaminate the entire container of solution. Store solutions in a cool, dark area, because direct light or excessive heat may reduce their strength, making them more susceptible to contamination.

Client Prep Tips:

- **Never leave cotton balls, cotton wool, or gauze sponges soaking in an antiseptic.**
- **Never dip cotton or gauze into the antiseptic container. Instead, pour some antiseptic into a small container, dip the cotton or gauze into this small container, and discard the unused antiseptic left over after client prep.**
- **Shaving the surgical site is not recommended, because it causes small nicks or cuts in the skin where bacteria can grow and multiply. Instead, hair may be clipped short.**

Properties of Common Antiseptics

Antiseptics vary between countries, and a variety of products are available throughout the world. This section notes the most common antiseptics and provides the trade names of commonly available products. In general, these have been studied extensively and their effectiveness is known. The information here reflects the most up-to-date scientific studies available. If possible, use these antiseptics, since others may not have been properly studied and their effectiveness may not be known.

Iodophors, such as povidone iodine (e.g., Betadine), contain iodine in a complex form, making them relatively nonirritating and nontoxic.

- **Antimicrobial spectrum:** Effective against a range of microorganisms.
- **Advantages:** Less irritating to the skin than iodine; can be used on mucous membranes.
- **Disadvantages:** Effectiveness is moderately reduced by blood or other organic material.
- **Usage:** Recommended for surgical scrub and client prep, and is the best antiseptic for use in the genital area, vagina, and cervix. Effective 1–2 minutes after application; for optimal effectiveness, wait several minutes after application. Use full strength; do not dilute.
- **Comments:** Iodophors are distinctly different from iodine. Iodophors are sudsy; iodine is not.

Chlorhexidine gluconate (e.g., Hibitane, Hibidens, Hibiscrub); **Chlorhexidine gluconate with cetrimide** (e.g., Savlon)

- **Antimicrobial spectrum:** Effective against a range of microorganisms, but has a minimal effect on tuberculosis and fungi.
- **Advantages:** Good, persistent effect; remains effective for at least 6 hours after being applied. Effectiveness is not reduced by organic material.
- **Disadvantages:** On rare occasions, products containing chlorhexidine have been reported to cause irritation, especially when used in the genital area. Effectiveness can be reduced by hard water, hand creams, and natural soaps.
- **Usage:** Recommended for surgical scrub and skin prep. Preparations without cetrimide are preferable. While products containing chlorhexidine are ideal for surgical scrub and skin prep, they may cause irritation if used in the genital area, vagina, or cervix. Chlorhexidine is the best alternative if an iodophor is not available.

- **Comments:** The concentration of chlorhexidine in products with the name Savlon may vary from one country to another. Savlon products containing at least 4% chlorhexidine are appropriate for use as antiseptics. Savlon products containing less than 4% chlorhexidine in an alcohol base are also adequate, but should not be used on mucous membranes.

Iodine; tincture of iodine (iodine and alcohol)

- **Antimicrobial spectrum:** Effective against a range of microorganisms.
- **Advantages:** Fast acting.
- **Disadvantages:** Can cause skin irritation. Effectiveness is markedly reduced by blood or other organic material.
- **Usage:** Too irritating for routine use in surgical scrub or for use on mucous membranes. Because of potential irritation when used for skin prep, iodine must be allowed to dry and then removed from the skin with alcohol.

Alcohol (60%–90% ethyl or isopropyl)

- **Antimicrobial spectrum:** Effective against a range of microorganisms.
- **Advantages:** Kills microorganisms rapidly. Most effective in reducing microorganisms. Effectiveness is moderately reduced by organic material.
- **Disadvantages:** Has a drying effect on skin. Cannot be used on mucous membranes.
- **Usage:** Cannot be used when skin is dirty; wash the area before applying. It must dry completely to be effective.
- **Comments:** 60–70% strength is most effective because alcohol must be diluted for optimal effectiveness, and it is also less drying to skin.

Para-chloro-meta-xyleneol, PCMX, chloroxylenol (all three also known as Dettol)

- **Antimicrobial spectrum:** Fairly effective against most microorganisms.
- **Advantages:** Has a persistent effect over several hours. Activity is only minimally reduced by blood or other organic material.
- **Disadvantages:** Less effective than chlorhexidine and iodophors.
- **Comments:** Not recommended for routine use. Antiseptic PCMX preparations containing alcohol should not be used on mucous membranes. Disinfectant preparations should not be used as antiseptics.

Establishing and maintaining a sterile field

A sterile field is created by placing sterile towels or surgical drapes around the surgical/ procedure site. A sterile field should also be established on the stand that will hold sterile instruments and other items needed during the procedure.

Items below the level of the draped client are outside the field and are not sterile. A gowned and gloved provider's sterile area

extends from the chest to the level of the sterile field. Sleeves are sterile from 5 cm above the elbow to the cuff.

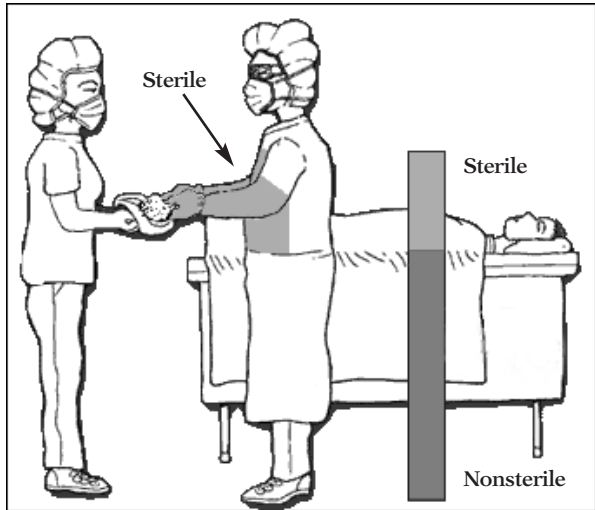

To maintain a sterile field:

- Allow only sterile items and personnel within the sterile field.
- Do not contaminate items when opening, dispensing, or transferring them.
- Consider any sterile item that has been penetrated (cut, wet, or torn) to be nonsterile.
- Never set up a sterile field near a door or an open window.
- When in doubt about whether or not an item is still sterile, consider it to be contaminated.

Good surgical technique

Meticulous attention to bleeding and gentle tissue handling during surgical and clinical procedures can help reduce the risk of infection. Post-procedure infections are more likely to occur in tissue that has been damaged due to rough or excessive manipulation during surgery or when there is excessive bleeding (because the tissue is then more susceptible to invasion by microorganisms).

Use of prophylactic antibiotics

The use of prophylactic antibiotics (giving antibiotics before a procedure to prevent infections from developing) does not take the place of good infection prevention. In general, prophylactic antibiotics may be indicated in contaminated or clean-contaminated surgical procedures, in those involving implantation of a foreign body, or when the client is severely immunosuppressed.

Prophylactic antibiotics are often prescribed inappropriately (e.g., when they are not effective against microorganisms likely to cause infections) or given at the wrong time in relation to the procedure (e.g., when given postoperatively instead of pre- or intraoperatively), thus decreasing the likelihood that they will have any effect.

Avoid routine use of prophylactic antibiotics: it increases costs and increases the likelihood of promoting antibiotic resistance.

Creating a safer surgical/procedure area

Specific rooms should be designated for performing surgical/clinical procedures.

Limiting the traffic, activities, and the number and movement of people in these areas will lower the risk of infection, since the number of people and amount of activity influence the number of potentially disease-causing microorganisms. To maintain a safer environment:

- Reduce the number of people permitted in the area. (It is important to restrict the number of people to only those involved in the activities being carried out.)
- Define the movement of people and activities within the area.
- Close doors and curtains during all procedures.
- Require that personnel in surgical areas wear clean clothes, a mask, a cap, and sturdy footwear.
- Enclose these areas to minimize dust and eliminate insects.
- Air-condition the areas, if possible.
- Disinfect and clean examination/operating tables, counters, instrument carts or trolleys, light handles, and any other surfaces that may have been contaminated with blood or other body fluids during a procedure before a new client is brought into the room.

Use and Disposal of Sharps

In health care settings, injuries from needles and other sharp items are the number-one cause of infections in staff from bloodborne pathogens. All staff who touch sharps are at risk of infection. Health care workers can be injured:

- When they recap, bend, or break hypodermic needles
- When they are stuck by a person carrying unprotected sharps
- When sharps show up in unexpected places, like linens
- During procedures in which they use many sharps, cannot see their hands, or are working in a small, confined space (such as during many gynecological procedures)
- When they handle or dispose of waste that contains used sharps
- When clients move suddenly during injections

Giving injections

Providers can be stuck or splashed with blood if a client moves suddenly; clients can be infected if the needle, syringe, or solution is contaminated. To minimize risks:

- Always warn the client before giving an injection.
- Always use a new or properly processed needle and syringe for every injection.

Before giving an injection, wash the injection site with soap and water if there is visible dirt on the skin. Wipe the client's skin at the injection site with an antiseptic solution to minimize the number of microorganisms and reduce the risk of infections. Using a fresh swab, wipe in a circular motion from the center outward. If alcohol is used, allow the alcohol to dry in order to provide maximum effectiveness in reducing microorganisms.

IV fluids and multidose vials

Infections may be transmitted through these items if proper procedures are not followed.

IV fluids. Unhook the needle or catheter from the IV line. Dispose of the needle in a sharps-disposal container. Throw away the catheter and IV line and any remaining fluid. Microorganisms can survive and grow in IV fluids; never use the same IV line and fluid bag/bottle with multiple clients.

Multidose vials. Before filling a syringe from a multidose vial, check the vial to be sure there are no leaks or cracks. Check the solution to be sure it is not cloudy and that there is no particulate matter in the vial. (Most solutions are clear, although some, like Depo-Provera, are milky.) Wipe

the top of the vial with a fresh cotton swab soaked with 60%–70% alcohol and allow it to air-dry. Always use a new or correctly processed hypodermic needle and syringe every time medication is withdrawn from a multi-dose vial. Reusing the same syringe with multiple clients—even if the needle is changed—is not a safe practice. Also, never leave one needle inserted in the vial cap for multiple uses. This provides a direct route for microorganisms to enter the vial and contaminate the fluid between each use.

Safe handling of sharps

Health care workers can accidentally stick each other when passing sharps during a procedure. Always pass sharps in such a way that the surgeon and assistant are never touching the item at the same time. This is known as the “hands-free” technique.

To use the hands-free technique:

- The assistant puts the sharps in a “safe zone” using a designated part of the instrument stand or area on the field where instruments can be placed.
- The assistant tells the service provider that the sharps are in the safe zone.
- The provider picks up a sharp item, uses it, and returns it to the safe zone.

Disposal and decontamination of sharps

Improper disposal of contaminated sharps can cause infection throughout the community. To avoid injuries during sharps disposal:

- Avoid recapping needles
- Do not bend, cut, or break needles
- Do not remove needles from syringes before disposal
- Dispose of sharps in a puncture-resistant sharps container, such as a metal box, heavy cardboard box, or an empty plastic jug
- Wear utility gloves when disposing of sharps containers

Recapping needles

Whenever possible, dispose of needles immediately without recapping them. When recapping is necessary (for example, to avoid carrying an unprotected sharp), always use the “one-hand” technique.

Steps of the One-Hand Technique



Step 1

Place the cap on a flat surface and remove your hand from the cap.



Step 2

With one hand, hold the syringe and use the needle to "scoop up" the cap.



Step 3

When the cap covers the needle completely, use the other hand to secure the cap on the needle hub. Be careful to handle the cap at the bottom only (near the hub).

Sharps-disposal containers

Use a puncture-resistant container for the disposal of used sharps. A sharps container may be made out of a heavy cardboard box, an empty plastic jug, or a metal container. Sharps-disposal containers should be located in any area where sharps are used (injection rooms, treatment rooms, operating theaters, labor and delivery rooms, and laboratories).

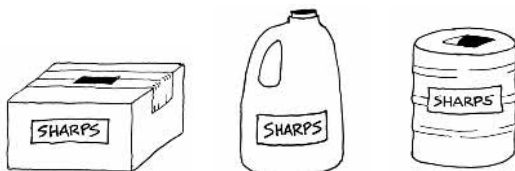

Decontaminating sharps

Improperly discarded sharps can cause infections: when possible make sharps unusable by incinerating them in an industrial incinerator. When this is not possible, decontaminate sharps before disposal. (For more information about proper disposal, see page 68.) Sharps should also be decontaminated before being processed for reuse. (For more information about decontamination, see page 25.)

Steps of Decontaminating Needles and Syringes



Step 1

Immediately after use, fill the assembled needle and syringe with a 0.5% chlorine solution, and draw the solution in and out several times. (More information about the 0.5% chlorine solution appears on page 26.)



Step 2

Drop the needle and syringe into a container of 0.5% chlorine solution, and let them soak for 10 minutes.



Step 3

Remove the needle and syringe from the solution, either by hand or using pickups (lifters, tongs, forceps). If using your hands, be sure to wear utility gloves.



Step 4

Dispose in a sharps container. Or if the syringe and needle are reusable, rinse with clean water, drawing the water in and out several times, or clean immediately.

Management of injuries

If you are exposed to blood or other body fluids:

- Immediately wash cuts or puncture wounds with soap and water.
- Flush splashes to the nose, mouth, or skin with water.
- Irrigate splashes to the eyes with water or saline.

There is no evidence that cleaning a wound with an antiseptic or squeezing a wound decreases the risk of infection. Do not use caustic agents, such as bleach, on sharp-object injuries. As a precaution, all staff who are at risk of exposure to blood or other body fluids should be vaccinated against hepatitis B.

Postexposure prophylaxis

Postexposure prophylaxis with drugs or other therapy can reduce the risk of transmission of some bloodborne pathogens. Whether postexposure prophylaxis is indicated following exposure to blood or other body fluids depends on a number of factors, including the infection status of the client whose blood or fluids are involved, the type of exposure (a splash to the skin versus a deep puncture wound), whether or not the exposed person has been vaccinated against hepatitis B, how much time has passed since the exposure, and the availability of drugs or other therapy.

Some therapies include:

- **For hepatitis B:** Hepatitis B immune globulin and hepatitis B vaccine can reduce the risk of infection after exposure to blood or other body fluids containing the hepatitis B virus.
- **For HIV:** Several antiretroviral drugs, used either alone or in combination, have been recommended to reduce the risk of HIV transmission following accidental exposure in health care workers. These include zidovudine (AZT, Retrovir), lamivudine (3TC, Epivir), indinavir (Crixivan), and nelfinavir (Viracept).
- **For hepatitis C:** There is no postexposure prophylaxis available for hepatitis C. Neither immune globulin nor antiviral drugs have been shown to reduce the risk of hepatitis C transmission.

If you, a co-worker, or a client has been exposed to blood or other body fluids, consult an infectious disease specialist familiar with postexposure prophylaxis, if possible.

Sharps Tips:

- **Handle hypodermic needles and other sharps minimally after use, and use extreme care whenever sharps are handled.**
- **Avoid recapping needles and do not bend, break, or cut them before disposal.**
- **Dispose of hypodermic needles, scalpel blades, and other sharps in puncture-resistant containers immediately (or as soon as possible) after use.**
- **Always wear utility gloves when disposing of sharps containers.**
- **Always wear utility gloves when washing sharps.**
- **Use the “hands-free” technique to pass sharps during clinical procedures.**

Instrument Processing

Proper processing is critical for reducing infection transmission during clinical or surgical procedures. Correct handling and processing also reduces staff's risk of infection.

The steps of processing

There are four steps to processing instruments and other items used during clinical and surgical procedures: decontamination, cleaning, sterilization or high-level disinfection (HLD), and use or storage.

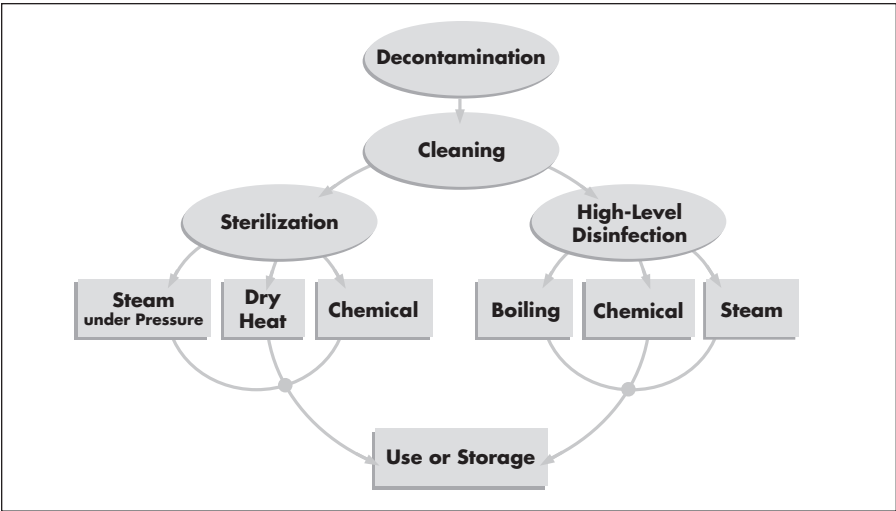

Step 1 Decontamination

The first step in processing instruments and other items for reuse, decontamination kills viruses (such as hepatitis B, other hepatitis viruses, and HIV) and many other microorganisms, making items safer to handle by the staff who perform cleaning and further processing. Decontamination makes items easier to clean by preventing blood, other body fluids, and tissue from drying on them. Cleaning is still necessary, however, since decontamination does not remove all of the body fluid, tissue, or dirt on the items.

It is important for staff to know how to decontaminate items, to know that they should place items in the decontamination bucket without splashing the solution, and to know that they should always rinse their gloves in a decontamination solution before removing them.

To decontaminate items, use a 0.5% chlorine solution or a solution made from another acceptable disinfectant. (Because chlorine is usually the cheapest, most universally available disinfectant, this booklet will focus on the use of a 0.5% chlorine solution.)

How to make a 0.5% chlorine solution

A solution that is too weak (less than 0.5% active chlorine) may not adequately kill microorganisms during the recommended time for soaking. A solution that is too strong (more than 0.5% active chlorine) may increase the cost of supplies by using more bleach than necessary and may damage instruments, other items, and environmental surfaces.

Because of their low cost and wide availability, chlorine solutions prepared from liquid or powdered bleach are recommended. A chlorine solution can be made from:

1. **Liquid household bleach.** (Sodium hypochlorite)
2. **Bleach powder.** Chlorine compounds available in powder form (calcium hypochlorite or chlorinated lime)
3. **Chlorine-releasing tablets.** (Sodium dichloroisocyanurate)

Chlorine-containing compounds are described as having a certain percentage of “active” (or available) chlorine. It is the active chlorine in these products that kills microorganisms. The amount of active chlorine is usually described as a percentage, and differs from one product to another. This is important so that a chlorine solution with 0.5% “active” chlorine can be prepared.

Note: In countries where French products are available, the amount of active chlorine is usually expressed in “degrees chlorum.” One degree chlorum is equivalent to 0.3% active chlorine.

About Chlorine

Chlorine is one of the oldest and most common compounds used as a disinfectant because:

- **It is a proven and powerful killer of microorganisms.**
- **It deodorizes.**
- **It is not poisonous to humans in the concentrations in which it is used.**
- **It leaves no poisonous residue.**
- **It is colorless, easy to handle, and economical to use.**

1. Using liquid household bleach

Chlorine in bleach comes in different concentrations. You can use any type of bleach, no matter what the concentration, to make a 0.5% chlorine solution by using the following formula:

$$[\% \text{ active chlorine in liquid bleach} \div 0.5\%] - 1 = \text{parts of water for each part bleach}$$

Note that “parts” can be used for any unit of measure (e.g., ounce, liter, or gallon) and need not even represent a defined unit of measure (e.g., a pitcher or container may be used).

Example: To make a 0.5% chlorine solution from bleach with 3.5% active chlorine, you must use 1 part bleach and 6 parts water:



$$[3.5\% \div 0.5\%] - 1 = [7] - 1 = 6 \text{ parts water for each part bleach}$$

2. Using bleach powder

If using bleach powder, calculate the ratio of bleach to water using the following formula:

$$[0.5\% \div \% \text{ active chlorine in bleach powder}] \times 1000 = \text{grams of powder for each liter of water}$$

Example: To make a 0.5% chlorine solution from calcium hypochlorite powder containing 35% available chlorine:

$$[0.5\% \div 35\%] \times 1000 = [0.0143] \times 1000 = 14.3 \text{ grams}$$

Therefore, you must dissolve 14.3 grams of calcium hypochlorite powder in 1 liter of water in order to get a 0.5% chlorine solution.

Note that when bleach powder is used, the resulting chlorine solution is likely to be cloudy (milky).

3. Using chlorine-releasing tablets

Follow the manufacturer’s instructions, since the percentage of active chlorine in these products varies. If the instructions are not available with the tablets from your supply source, ask for the product’s instruction sheet or contact the manufacturer.

Steps of Decontamination



Step 1

Immediately after use, decontaminate instruments and other items by placing them in a plastic container of 0.5% chlorine solution. Let them soak for 10 minutes. A container of this solution should be kept in every operating theater and procedure room so that used items can be placed directly into the bucket. Service providers should put instruments and other items in the chlorine solution as soon as they are finished using each item.



Step 2

After 10 minutes, remove the items from the chlorine solution and either rinse with water or clean immediately. Do not leave items in the solution for more than 10 minutes, since excessive soaking in the solution can damage instruments and other items. Always wear utility gloves when removing instruments and other items from a chlorine solution.

It may be useful to set up a bucket of tap water next to the bucket of decontamination solution. This way, when the items are ready to be removed from the decontamination solution, they can be placed in the water until the appropriate staff member is ready to clean them.

Items that require special consideration:

- **Reusable needles and syringes:** Fill the assembled needles and syringes with a 0.5% chlorine solution, flush several times (draw up and expel the 0.5% chlorine solution into and out of the syringe), and soak for 10 minutes. Rinse by flushing several times with clean water or clean immediately. Always use pickups and wear utility gloves when removing needles and syringes from the solution. (*For more information on the proper handling of these items, see pages 20–24.*)
- **Gloves:** Before removing contaminated gloves, dip gloved hands into a 0.5% chlorine solution to rinse the outer surfaces and remove blood, other fluids, and tissue. Carefully remove gloves without touching the outer surface with bare hands. Do not snap the gloves. If the gloves are disposable or are not intact, dispose of them properly. If they are surgical gloves that will be processed for reuse, place them in a container of 0.5% chlorine solution and soak for 10 minutes before cleaning. Rinse or clean immediately. To avoid tearing or puncturing gloves during decontamination, place them in a different container than the one used to decontaminate instruments and other items.

- **Linens (caps, gowns, masks, and surgical drapes):** Decontamination of linens is impractical and is not recommended. Handle, transport, and process linens that are soiled with blood, other body fluids, secretions, and excretions in a way that prevents exposure to skin and mucous membranes, contamination of clothing, and transfer of microorganisms to clients or the environment. When transporting linens to washing areas, place the linens in leakproof containers or fold them so that the portions that are contaminated are on the inside, surrounded by dry linen. Always wear heavy utility gloves when handling, transporting, and processing used linens, and wash hands immediately after removing gloves. If linen will be processed outside of the facility, make sure that the person who transports them to the processing site wears utility gloves.
- **Storage containers:** Fill containers with a 0.5% chlorine solution and soak for 10 minutes before cleaning. Rinse or clean immediately.
- **Laparoscopes:** There is no effective way to decontaminate laparoscopes and cables. They cannot be soaked in chlorine solution, since chlorine can damage the laparoscope and cable. In addition, alcohol should not be used, as it can fog the lens or dissolve the cement holding the lens in place. When handling laparoscopes, always wear utility gloves.
- **Instruments used during manual vacuum aspiration (MVA):** Leave the cannula attached to the syringe and flush the syringe with a 0.5% chlorine solution one or two times. This will help remove any blood and tissue remaining in the cannula. Drop the assembled cannula and syringe into the 0.5% chlorine solution and soak for 10 minutes before cleaning. Rinse by flushing the assembled cannula and syringe three times with clean water, or clean immediately.

Step 2 Cleaning

While decontamination makes items safer to handle, cleaning, the second step in processing, removes organic material, dirt, and foreign matter that can interfere with sterilization or HLD. Cleaning also drastically reduces the number of microorganisms, including bacterial endospores, on instruments and other items.

Cleaning refers to scrubbing with a brush, detergent, and water and is a crucial step in processing. Without cleaning, further processing might not be effective because:

- Microorganisms trapped in organic material may be protected and survive further processing.
- Organic material and dirt can make the chemicals used in some processing techniques less effective.

Detergent is important for effective cleaning, because water alone will not remove protein, oils, and grease. When detergent is dissolved in water, it breaks up and dissolves or suspends grease, oil, and other foreign matter, making them easy to remove. Do not use hand soap for cleaning instruments and other items, because the fatty acids contained in the soap will react with the minerals of hard water, leaving a residue or scum that is difficult to remove.

Steps of Cleaning

Always wear utility gloves, a mask, and protective eyewear when cleaning instruments and other items. Avoid using steel wool or abrasive cleansers such as Vim or Comet. These products can scratch or pit metal or stainless steel, resulting in grooves that can become a nesting place for microorganisms. This also increases the potential for corrosion of the instruments and other items.

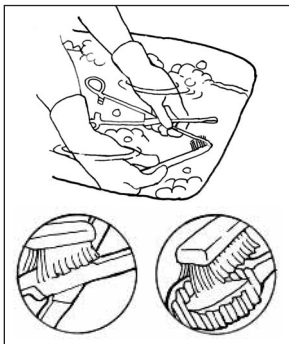

Step 1

Using a soft brush or old toothbrush, detergent, and water, scrub instruments and other items vigorously to completely remove all blood, other body fluids, tissue, and other foreign matter. Hold items under the surface of the water while scrubbing and cleaning to avoid splashing. Disassemble instruments and other items with multiple parts, and be sure to brush in the grooves, teeth, and joints of items where organic material can collect and stick.

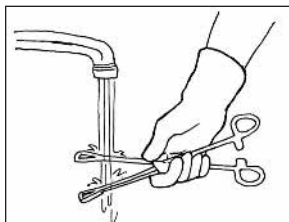

Step 2

Rinse items thoroughly with clean water to remove all detergent. Any detergent left on the items can reduce the effectiveness of further chemical processing.

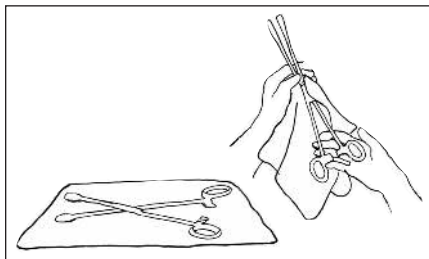

Step 3

Allow items to air-dry (or dry them with a clean towel).

Note: Instruments that will be further processed with chemical solutions must dry completely to avoid diluting the chemicals; items that will be high-level disinfected by boiling or steaming do not need to be dried first.

Items that require special consideration:

- **Reusable needles and syringes:** Disassemble the needle and syringe, then wash with detergent and warm water to remove all particles. If a stylet or wire is available, insert it through the needle to make sure the needle is not clogged. Reassemble and rinse with clean water by flushing with water (drawing in and expelling the water) at least three times. Detach the needle and inspect it to make sure the hub area is clean, the needle is not bent, and the tip is not damaged. Check the syringe to make sure the seal is good and the markings are readable. Air-dry needles; air- or towel-dry syringes.
- **Surgical gloves:** To avoid tearing gloves, handle with care: do not scrub with a brush, and always wash gloves separately from other items. Wash gloves with detergent and warm water, and rinse them in clean water until all detergent is gone. Check for holes by inflating the gloves with air and holding them underwater (air bubbles will appear if there are holes), or fill the gloves with water and check for leaks. Towel-dry inside and out, or air-dry by hanging gloves in an area of low activity.
- **Linens (caps, gowns, masks, and surgical drapes):** Wash with detergent and hot water and rinse with clean water. Air- or machine-dry. To reduce the risk of exposure to infectious material, machine washing is recommended. When machine washing is not possible, staff who wash linens by hand should wear protective gear, such as utility gloves, waterproof aprons, and either faceshields or eyecovers and a mask to reduce the likelihood of exposure to blood and other body fluids.
- **Instruments used during MVA:** Disassemble the syringe completely (including removing the collar stop and the O-ring on the plunger. On a double-valve syringe, also remove the O-ring from inside the valve). Wash the parts of the syringe and the cannula with detergent and water. Scrub the syringe with a soft brush (e.g., a toothbrush). Do not use brushes or other objects to try to remove blood or tissue from the inside of the tip of the cannula; this may cause scratches that can trap materials and microorganisms or may damage the tip, increasing the risk of breakage. Instead, try to dislodge material in the tip by flushing the cannula with water (drawing up and expelling water) or flicking the top of the cannula with your gloved fingertips. Rinse with clean water and air-dry (drying is not necessary if the cannula will be further processed by boiling or steaming). Dry the syringe thoroughly before reassembling it.

Step 3 Sterilization or HLD

Sterilization ensures that items are free of all microorganisms (bacteria, viruses, fungi, and parasites), including bacterial endospores, that can cause infections in clients. Because sterilization kills all microorganisms, it is recommended for items like needles and surgical instruments that come in contact with the bloodstream or tissues under the skin. When sterilization is not available, HLD is the only acceptable alternative for these items.

Using sterilization

The effectiveness of any method of sterilization depends on the amount and type of microorganisms, organic material (blood, other fluids, tissues), and other matter (such as dirt) present on the item and the amount of protection the item gives the microorganisms (such as whether the item has grooves or other areas in which microorganisms can hide). Therefore, it is important to thoroughly clean instruments and other items before sterilization:

- To reduce the number of microorganisms
- To eliminate fluids or tissue remains
- To remove contaminants that can collect in joints, grooves, and teeth of items

There are three methods of sterilization: steam sterilization (also known as “autoclaving” or “moist heat under pressure”), dry-heat sterilization (electric oven), and chemical (“cold”) sterilization. You should have more than one method of sterilization or HLD available to use as a backup for when your equipment breaks down, supplies run low, or electricity is unavailable.

Note: Boiling is *not* a method of sterilization.

Wrapping items before sterilization

Wrapping items before steam and dry-heat sterilization helps decrease the likelihood that sterilized items will be contaminated before use. Under optimal storage conditions and with minimal handling, properly wrapped items can be considered sterile as long as they remain intact and dry. To wrap items for steam sterilization, use two layers of paper, newsprint, or muslin or cotton fabric. Do not use canvas for steam sterilization, since steam may not penetrate this material. When wrapping items for dry-heat sterilization, use foil, double-layered cotton, or muslin fabric.

Steps of Wrapping Items for Sterilization

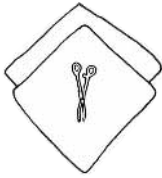

Step 1

Place the instrument or other item in the center of the top wrapper. The wrapper should be positioned so that the points—not the flat edges—are at the top, bottom, and sides.

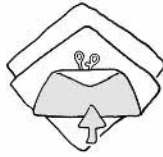

Step 2

Fold the bottom section of the *top* wrapper to the center, and fold back the point.



Step 3

Fold the left section to the center, and fold back the point.

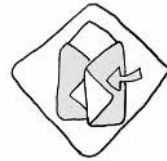

Step 4

Fold the right section to the center, and fold back the point.

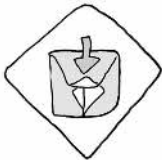

Step 5

Fold the top section to the center, and fold back the point.

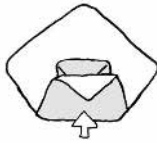

Step 6

Fold the bottom section of the *bottom* wrapper to the center, and fold back the point.

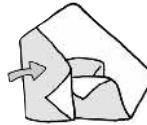

Step 7

Fold the left section to the center, and fold back the point.

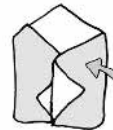

Step 8

Fold the right section to the center, and fold back the point.

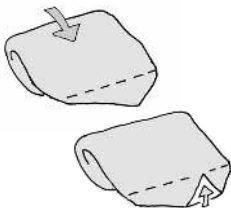

Step 9

Fold the top section to the center, and fold back the point.

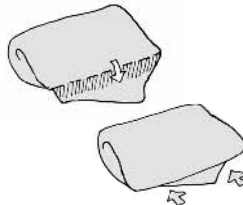

Step 10

Tuck the point under the right and left sections.



Step 11

Fasten the folds securely, using autoclave tape, if available.

1. Steam sterilization (autoclaving)

Steam sterilization in an autoclave is one of the most common forms of sterilization used in health care facilities. Steam sterilization requires moist heat under pressure, so there must be sources of both water and heat. Heat can be provided by electricity or by another fuel source (e.g., kerosene burner), depending on the type of autoclave being used.

It is important to know whether you are using an autoclave or a dry-heat oven, since different procedures are used with each. Remember that if you are using an autoclave, it must have a source of water (either the machine is hooked up directly to a water source or water is put into the machine before the cycle begins) and a pressure gauge.

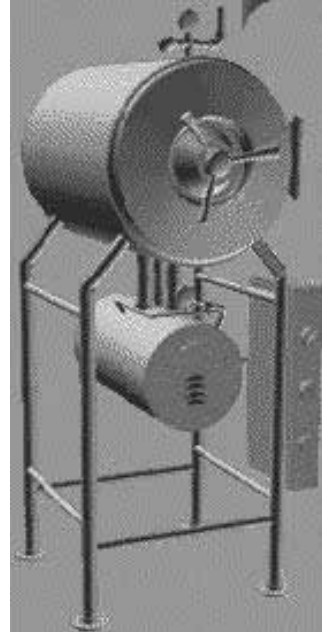

Steps of Steam Sterilization

Step 1

Decontaminate, clean, and dry all instruments and other items to be sterilized.

Step 2

Open or unlock all jointed items, such as hemostats and scissors, and disassemble those with sliding or multiple parts. (This allows steam to reach all surfaces of the item.) Avoid arranging the items together tightly, because this prevents steam from reaching all surfaces.

Step 3

If items are to be wrapped before steam sterilization, use two layers of paper, newsprint, or cotton or muslin fabric (do not use canvas). Instruments and other items should not be placed in a closed container. If drums are being used, make sure the holes of the drum are open.

Step 4

Arrange all packs, drums, or unwrapped items in the chamber of the autoclave in a way that allows steam to circulate freely.

continued

Steps of steam sterilization continued

Step 5

Because there are many types of autoclaves, this booklet cannot provide specific instructions for each. Follow the manufacturer's instructions whenever possible. In general, sterilize wrapped items for 30 minutes and unwrapped items for 20 minutes at 121°C (250°F) and 106 kPa (15lb/in²) pressure. (Do not begin timing until the autoclave reaches the desired temperature and pressure. If you forget to start timing the procedure, start timing at the point at which you realize this.)

Note: The units of pressure marked on an autoclave's pressure gauge may be different on different machines. The following amounts (which are approximately equivalent) are the desired pressure for autoclaving:

- 15 lb/in² (15 pounds per square inch)
- 106 kPa (106 kilopascals)
- 1 atm (1 atmosphere)
- 1 kgf/cm² (1 kilogram of force per square centimeter)
- 776 torr
- 1 bar
- 776 mm Hg (776 millimeters of mercury)

Step 6

If the autoclave is automatic, the heat will shut off and the pressure will begin to fall once the sterilization cycle is complete. If the autoclave is not automatic, turn off the heat or remove the autoclave from the heat source after 30 minutes if items are wrapped, 20 minutes if items are unwrapped. Wait until the pressure gauge reads "zero" to open the autoclave. Open the lid or door to allow the remaining steam to escape. Leave instrument packs or items in the autoclave until they dry completely (which could take up to 30 minutes).

Note: Items must be removed dry; damp packs will draw microorganisms from the environment and should be considered contaminated.

Step 7

Remove the packs, drums, or unwrapped items from the autoclave (use sterile pickups for handling unwrapped items). To prevent condensation, place packs or drums on a surface padded with paper or fabric until they are cool. Do not store packs, drums, or unwrapped items before they reach room temperature (which may take several hours).

Step 8

Store items properly as follows:

- **Wrapped items.** Under optimal storage conditions and with minimal handling, properly wrapped items can be considered sterile as long as they remain intact and dry. For optimal storage, place sterile packs in closed cabinets in areas that are not heavily trafficked, have moderate temperature, and are dry or of low humidity. When in doubt about the sterility of a pack, consider it contaminated and resterilize the items.
- **Unwrapped items.** Use unwrapped items immediately after removal from the autoclave or keep them in a covered, dry, sterile container for up to one week.

Pressure-cooker-type autoclaves

Pressure-cooker-type autoclaves are common (especially in rural areas) and often do not come with instructions. The following can be used as instructions:

- Put water in the bottom of the autoclave (up to the ridge located on the inner wall).
- Place items in the autoclave and arrange them loosely, so that the steam can circulate around them.
- Place the autoclave over the heat source (e.g., electric stove, kerosene burner) and turn to high heat. Once steam is emitted from the pressure valve, begin timing the sterilization cycle. (For this type of autoclave, 20 minutes is suggested, regardless of whether items are wrapped or unwrapped.)
- Turn the heat down, but make sure that steam continues to come out of the pressure valve. This will reduce the amount of fuel used.
- After 20 minutes, remove the autoclave from the heat source, open the pressure valve to release the steam, and allow the autoclave to cool for 15–30 minutes before opening it.

Each time you prepare to use the autoclave, check the gaskets, gauges, and pressure and safety valves for defects. Clean the chamber and cover regularly.

Autoclave maintenance

If you use steam sterilization at your facility, the autoclave should be checked each time it is used to make sure that it is functioning properly. If any repairs are necessary, they should be made before the autoclave is used again. If the autoclave is faulty, sterilization will not be achieved. The autoclave is not working correctly:

- If steam comes out of the safety valve instead of the pressure valve. If this happens, the pressure valve must be cleaned and inspected.
- If steam comes out from under the lid or around the door. If this happens, the gasket must be cleaned and dried or replaced.

Routine maintenance should become standard procedure. (Follow the manufacturer's instructions whenever possible, since autoclave maintenance varies depending on the type of autoclave used.)

General Guidelines for Routine Maintenance that Are Likely to Apply to Many Autoclaves

Daily

- Remove the outlet screen, and clean with detergent and a brush under running water.

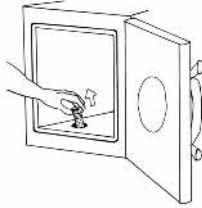

- Clean the chamber using a cloth. Do *not* use abrasive cleansers or steel wool; they will scratch the surface and increase corrosion.

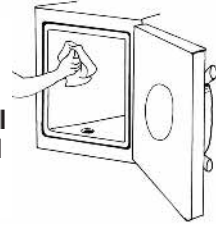

- Clean the door or lid gaskets with a cloth and check for defects. Replace defective gaskets.

- Clean the shelves in the autoclave or the basket or cart that holds packs (including the wheels of the cart) with detergent and a cloth.



Weekly

Check the manufacturer's instructions for maintenance of the exhaust line. If the instructions are unavailable, flush the exhaust line or chamber drain to keep it free of material that may interfere with air and steam leaving the chamber, as follows:

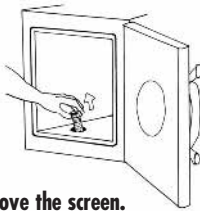

- 1 Remove the screen.



- 2 Pour 1 liter of detergent and hot water solution down the drain with a funnel.



- 3 Pour 1 liter of hot water down the drain to rinse out the detergent solution.

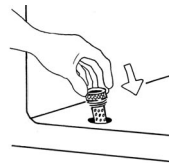

- 4 Replace the screen.

Steam sterilization of surgical gloves

Gloves may be powdered before steam sterilization to prevent them from sticking together and to make them easier to put on. However, powder has been shown to lead to inflammatory reactions in clients (with subsequent granuloma or adhesion formation) and may cause increased development of latex allergies or dermatitis in health care workers. If powder is used, use only absorbable powders, such as starch. (Do not use talcum powder, which is nonabsorbable.) To reduce the risk of inflammatory reactions in clients, staff should rinse gloved hands with sterile water or saline solution after putting on powdered gloves and before handling instruments or performing a clinical procedure.

Wrapping gloves before steam sterilization helps decrease the likelihood that they will become contaminated before use. Use paper, newsprint, or muslin or cotton fabric. Do not use canvas. Wrap gloves with a cuff so that they can be easily put on without contaminating them. Do not roll gloves into balls before sterilization (this makes it difficult for steam to reach all surfaces of the gloves, making sterilization ineffective).

Steps of Wrapping Gloves for Steam Sterilization

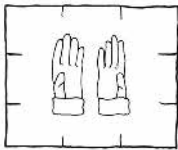

Step 1

Place one pair of gloves in the center of the wrapper. The wrapper should be positioned so that the flat edges—not the points—are at the top, bottom, and sides.

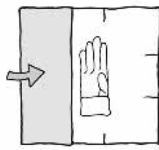

Step 2

Fold the left section to the center.

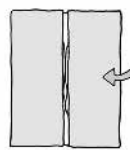

Step 3

Fold the right section to the center.

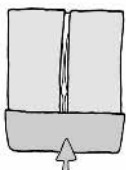

Step 4

Fold the bottom section halfway to the center (one-quarter of the way up).

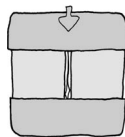

Step 5

Fold the top section halfway to the center (one-quarter of the way down).

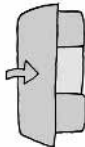

Step 6

Fold the packet in half vertically, either from left to right or from right to left.



Step 7

Mark on the outside of the wrapper the end at which the gloves' cuffs are positioned. (This will help ensure that the gloves will be in the correct position when the provider opens the pack to put them on.)

2. Dry-heat sterilization (electric oven)

Dry-heat sterilization requires high heat for a specific period of time. For sterilization to be achieved, a constant supply of electricity is necessary. Because of the high temperatures, only glass or metal objects can be sterilized by dry heat. Do not use this method for other items, such as surgical gloves, which may melt or burn.

It is important to know whether you are using an autoclave (steam sterilizer) or a dry-heat oven, since different procedures are used with each. Remember that a dry-heat oven does not use water or have pressure gauges.

Steps of Dry-Heat Sterilization

Step 1

Decontaminate, clean, and dry all items to be sterilized.

Step 2

Either 1) wrap the items using foil, double-layered cotton, or muslin fabric; 2) put unwrapped items on a tray or shelf; or 3) place items in a metal, lidded container.

Note: Because dry-heat sterilization works by raising the temperature of the entire item to the designated temperature, it is not necessary to open or unlock hinged instruments or other items or to disassemble those with sliding or multiple parts. In addition, instruments and other items can be placed in closed containers.

Step 3

Place items in the oven and heat to the correct temperature (the oven must contain a thermometer or temperature gauge). Use the following list to determine the time required to sterilize items at different temperatures. Do not begin timing until the oven reaches the desired temperature, and do not open the oven once timing has begun. (Use a timer or make sure to record the time.) If you forget to start timing the procedure, start timing at the point at which you realize this.

<u>Temperature</u>	<u>Time</u>
170°C (340°F)	1 hour
160°C (320°F)	2 hours
150°C (300°F)	2.5 hours
140°C (285°F)	3 hours

Note: This list shows the amount of time that items must be kept at the desired temperature to ensure that sterilization is achieved. Keep in mind that the total cycle time—including heating the oven to the correct temperature, sterilization, and cooling—is usually twice as long as the time noted here. Because dry heat can dull sharp instruments and needles, these items should not be sterilized at temperatures higher than 160°C.

Step 4

Leave items in the oven to cool. When they are cool, remove items and use or store immediately. (Use sterile pickups to remove unwrapped items.)

continued on page 40

Steps of dry-heat sterilization continued

Step 5

Store items properly, as follows:

- **Wrapped items.** Under optimal storage conditions and with minimal handling, properly wrapped items can be considered sterile as long as they remain intact and dry. For optimal storage, place sterile packs in closed cabinets in areas that are not heavily trafficked, have a moderate temperature, and are dry or of low humidity. When in doubt about the sterility of a pack, consider it contaminated and resterilize the items.
- **Unwrapped items.** Use unwrapped items immediately after removal from the oven or keep them in a covered, dry, sterile container for up to one week.

Maintenance of ovens

If you use dry-heat sterilization at your facility, routine maintenance is important to ensure that the oven is functioning properly. If the oven does not reach the correct temperature, sterilization will not be achieved. Be sure to:

- Keep the oven clean.
- Check that the temperature gauge is working correctly on a regular basis—every few weeks is sufficient—by putting a thermometer in the oven and comparing the temperature reading with the one on the gauge.

3. Chemical (“cold”) sterilization

Chemical sterilization is used for items that are heat sensitive or when methods that require heat are unavailable. Items are sterilized by soaking them in an appropriate chemical solution (such as one containing glutaraldehyde) and rinsing them in sterile water.

Cidex, which contains glutaraldehyde, is a commonly available solution used for sterilization. Other products containing glutaraldehyde or other chemical sterilants may be locally available, but you should make sure that the solution you want to use is appropriate for sterilization. Remember that:

- Glutaraldehyde is irritating to the skin, eyes, and respiratory tract. When using it, wear gloves, limit your exposure time, and keep the area well ventilated.
- The length of time that commercially available glutaraldehyde solutions can be used varies, usually from 14–30 days. Always follow the manufacturer’s instructions regarding proper storage temperatures and expiration date. Solutions should be replaced anytime they become cloudy.
- Formaldehyde is potentially cancer causing and extremely irritating to the skin, eyes, nose, and respiratory tract. Therefore, routine use of formaldehyde for sterilizing instruments and other items is *not* recommended.

Steps of Chemical Sterilization

Step 1

Decontaminate, clean, and thoroughly dry all instruments and other items to be sterilized. Water from wet instruments and other items dilutes the chemical solution, thereby reducing its effectiveness.

Step 2

Prepare the glutaraldehyde or other chemical solution by following the manufacturer's instructions or use a solution that was prepared previously, as long as it is clear (not cloudy) and has not expired. (Most commercially available glutaraldehyde solutions can be used for at least two weeks after preparation; follow the manufacturer's instructions. Ideally, an indicator strip should be used each time the solution is to be used to determine if the solution is still effective.) After preparing the solution, put it in a clean container with a lid. Always mark the container with the date the solution was prepared and the date it expires.

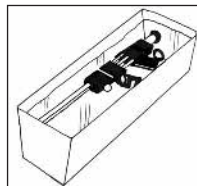

Step 3

Open all hinged instruments and other items and disassemble those with sliding or multiple parts; the solution must contact all surfaces in order for sterilization to be achieved. Completely submerge all instruments and other items in the solution; all parts of the instruments and other items should be under the surface of the solution. Place any bowls and containers upright, not upside down, and fill with the solution.

Step 4

Follow the manufacturer's instructions regarding the time necessary for sterilization to be achieved. In general, if the solution contains glutaraldehyde, cover the container, and allow the instruments and other items to soak for at least 10 hours. Do not add or remove any instruments or other items once timing has begun.

Step 5

Remove the instruments and other items from the solution using large, sterile pickups (lifters, cheatle forceps).

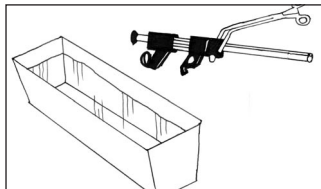

Step 6

Rinse thoroughly with sterile water to remove the residue that chemical sterilants leave on instruments and other items; this residue is toxic to skin and tissues. *Note:* Boiled water is not sterile, because boiling does not guarantee that bacterial endospores have been killed. Therefore, rinsing with boiled water can contaminate sterilized instruments and other items.



Step 7

Proper storage is as important as the sterilization process itself. Place the instruments and other items on a sterile tray or in a sterile container and allow to air-dry before use or storage. Use the instruments and other items immediately or keep in a covered, dry, sterile container and use within one week.

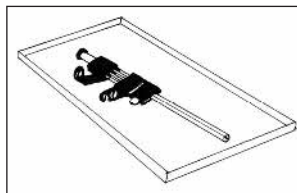

Monitoring the effectiveness of sterilization

There are three ways to monitor the effectiveness of sterilization:

- 1. Mechanical indicators.** These indicators, which are part of the sterilization equipment (the autoclave or dry-heat oven), record and allow you to observe time, temperature, and/or pressure readings during the sterilization cycle.
- 2. Chemical indicators.** These include:
 - Tape with lines that change color when the intended temperature is reached
 - Pellets in glass tubes that melt, indicating that the intended temperature and time have been reached
 - Indicator strips that show that the intended combination of temperature, time (and, in an autoclave, steam) has been achieved
 - Indicator strips that show that sterilization chemicals are still effective
- 3. Biological indicators.** These indicators use heat-resistant bacterial endospores to demonstrate whether or not sterilization has been achieved. (If the bacterial endospores have been killed after sterilization, you can assume that all other microorganisms have been killed as well.) The advantage of this method is that it directly measures the effectiveness of sterilization. The disadvantage is that this indicator is not immediate, as are mechanical and chemical indicators. Bacterial culture results are needed before sterilization effectiveness can be determined.

Recommended monitoring system:

- Record all information (temperature, time, pressure, or all three, depending on the method being used) in a log each time you perform sterilization, and review the log after each load. (Some sterilization equipment has a built-in recording chart that will do this for you.)
- For methods that require heat or steam, place heat- and steam-sensitive indicators on the inside and outside of each pack.
- Perform testing with biological indicators weekly (or monthly, if testing weekly is not possible).
- If using chemicals, use an indicator strip to determine whether the solution is still effective before performing sterilization and replace the solution if necessary.

In case of failure:

If monitoring indicates a failure in sterilization, immediately attempt to determine the cause of the failure. First, check that equipment is being used correctly. If correct use of equipment has been documented and monitoring still indicates a failure in sterilization, discontinue use of the equipment and have it serviced. Any items processed in the faulty equipment should be considered nonsterile and must be processed again when the equipment is functioning.

Special considerations

Special considerations must be taken when sterilizing liquids, gloves, reusable needles and syringes, linens, and the instruments used during manual vacuum aspiration.

Liquids

Liquids (such as water used to rinse items after chemical sterilization) can be sterilized only by steam sterilization, not by dry-heat or chemical sterilization. Special procedures must be followed to safely and properly sterilize liquids.

Liquids must be sterilized separately from other items, such as instruments or linens. Place liquids in heat-resistant glass (e.g., Pyrex) bottles with self-sealing caps, and autoclave them at the same temperature and pressure used for other items. The time necessary to autoclave liquids depends on many factors, the most important of which is the volume of liquid being autoclaved. In general:

- 75–100 mL = 20 minutes
- 250–500 mL = 25 minutes
- 1000 mL = 30 minutes
- 1500 mL = 35 minutes
- 2000 mL = 40 minutes

Once sterilization is complete, the chamber pressure must be released slowly—over a period of at least 10–15 minutes. Rapid release will cause liquids to boil violently, which may cause the caps to blow off or the bottles to burst. Open the autoclave door slightly and allow liquids to cool for approximately 30 minutes before removal.

Surgical gloves

Whenever possible, use disposable surgical gloves that arrive from the manufacturer in a sterile package and are thrown away after one use. Gloves are difficult to process, and processing may make gloves brittle or introduce tiny tears or holes. When surgical gloves must be processed, steam sterilization must be used. Gloves will melt in dry-heat ovens, and chemical sterilization is impractical because of the difficulty in rinsing off chemical residue. If possible, wrap gloves before sterilization (see page 38).

Reusable needles and syringes

Whenever possible, use disposable needles and syringes, since these items are difficult to process correctly. If these items must be reprocessed, use the following instructions. (**Note:** Chemical sterilization is not recommended, since it is difficult to adequately rinse off chemical residue, which may interact with or inactivate the solution being injected).

- **For steam sterilization:** Flush needles with boiled water just before wrapping. (A small amount of water is needed to steam-sterilize items with lumens or small openings.)
- **For dry-heat sterilization:** Because high temperatures can dull sharp edges, reusable needles should not be sterilized at temperatures higher than 160°C (320°F). Plastic syringes will melt at this temperature and should not be processed with dry heat.

Linens (gowns and surgical drapes)

Only steam sterilization should be used for these items. Many fabrics burn at the high temperatures used for dry heat, and the quantity of sterile water that would be needed and the high risk of contamination during drying make chemical sterilization impractical. Packs containing gowns, drapes, and other linens should not be more than 30 x 30 x 50 cm (12 x 12 x 20 in.) or 5 kg (12 lb.) to allow steam to penetrate the items adequately. Place packs containing linens on their sides to make it easier for the steam to penetrate. (It is easier for steam to go through folds than through flat, compressed surfaces.)

Instruments used during MVA

It is best to chemically sterilize the cannula, but sterilization of the syringe after decontamination and proper cleaning is not necessary (it does not come in contact with the client and is used only as a source of vacuum and as a receptacle for blood and tissue). Sterilization may decrease the life of the syringe, since sterilization damages the syringe over time. If your facility requires sterilization of the syringe, it may be sterilized using chemicals. (Neither the cannula nor the syringe can withstand steam or dry-heat sterilization: the syringe valve will be destroyed, and the cannula will melt.)

Soak the cannula and syringe in a chemical solution such as glutaraldehyde. (If available, ethylene oxide gas may be used.) Be sure that all parts of the syringe are completely submerged and that the barrel is filled with the solution. Be sure that the cannula is completely submerged and filled with the solution.

Using high-level disinfection

HLD eliminates bacteria, viruses, fungi, and parasites, but does not reliably kill all bacterial endospores, which cause diseases such as tetanus and gas gangrene. Because sterilization kills all microorganisms, including bacterial endospores, it is preferable for instruments and other items that will come in contact with the bloodstream or tissues under the skin. When sterilization is not available or feasible, HLD is the only acceptable alternative to sterilization for these items. HLD is also suitable for items

that will come in contact with broken skin or intact mucous membranes.

Note: Flaming (holding an item in a flame) is not an effective method of HLD because it does not effectively kill all microorganisms.

The effectiveness of HLD depends on the amount and type of microorganisms, organic material (blood, other fluids, tissues), and other matter (such as dirt) present on the item and the amount of protection the item gives the microorganisms (such as whether the item has grooves or other areas in which microorganisms can hide). Therefore it is important to thoroughly clean instruments and other items before HLD:

- To reduce the number of microorganisms
- To eliminate fluids or tissue remains
- To remove contaminants that can collect in joints, grooves, and teeth of items.

There are three methods of HLD: boiling, chemical HLD, and steaming. You should have more than one method of sterilization or HLD available to use as a backup for when your equipment breaks down, supplies run low, or electricity is unavailable. Many facilities use a method of HLD as a backup to their primary method of sterilization.

1. HLD by boiling

Boiling is a simple method of HLD that can be performed in any location that has access to clean water and a heat source. Using this method, instruments and other items are placed in a pot or boiler and the water is heated to boiling for 20 minutes.

Note: A white, scaly deposit may be left on items that have been boiled frequently and on the pot or boiler itself. These are lime deposits caused by lime salts in the water. To minimize lime deposits:

- Add some vinegar to the water to remove deposits on the items or the inside of the boiler.
- Boil the water for 10 minutes to precipitate the lime (to make it come out of the water and settle on the bottom or sides of the boiler instead of on the items being boiled) before the items are added.
- Use the same water throughout the day, adding only enough to keep the items below the surface.
- Drain and clean out the boiler at the end of each day.

Steps of HLD by Boiling

Step 1

Decontaminate and clean all instruments and other items to be high-level disinfected.

Step 2

Open all hinged instruments and other items and disassemble those with sliding or multiple parts. Place any bowls and containers upright, not upside-down, and fill with water. Because water must touch all surfaces for HLD to be achieved, completely submerge all instruments and other items in the water in the pot or boiler.



Step 3

Cover the pot or close the lid on the boiler and bring the water to a gentle, rolling boil.



Step 4

When the water comes to a rolling boil, start timing for 20 minutes. Use a timer or make sure to record the time that boiling begins. From this point on, do not add or remove any additional water, instruments, or other items.



Step 5

Lower the heat to keep the water at a gentle, rolling boil; too vigorous a boil will cause the water to evaporate and may damage the instruments and other items if they bounce around the container and hit the sidewalls and other instruments or items. The lower heat also saves fuel/electricity.

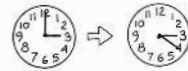

Step 6

After 20 minutes, remove the instruments and other items using dry, high-level disinfected pickups (lifters, cheatele forceps). Place the instruments and other items on a high-level disinfected tray or in a high-level disinfected container, away from insects and dust and in a low-traffic area. Allow to air-dry before use or storage. Never leave boiled instruments and other items in water that has stopped boiling; they can become contaminated as the water cools down.



Step 7

Use instruments and other items immediately or keep in a covered, dry, high-level disinfected container and use within one week.

Tips for HLD by Boiling:

- Items must be completely covered with water. Open all hinged instruments and disassemble items with sliding or multiple parts.
- Always boil for 20 minutes. Start timing when the water reaches a rolling boil.
- Do not add or remove anything once boiling begins.

2. Chemical HLD

Chemical HLD is used for heat-sensitive items, like laparoscopes, or when a heat source is not available. Chemical HLD is different from chemical sterilization because:

- Either glutaraldehyde or chlorine may be used for HLD. (Chlorine cannot be used for sterilization.)
- The soaking time is shorter for HLD.
- HLD items may be rinsed with boiled water. (Sterilized items must be rinsed with *sterile* water.)

About Disinfectants

Disinfectants are used to kill microorganisms on inanimate objects; they should not be used on skin or mucous membranes. Disinfectants are used in three ways:

- **During decontamination:** A disinfectant is used as the solution for decontamination.
- **During chemical HLD and sterilization:** Certain disinfectants can be used to sterilize or high-level disinfect instruments and other items.
- **During housekeeping:** Disinfectants are used to make the disinfectant cleaning solution used to clean high-risk areas.

There are two types of disinfectants:

1. **High-level disinfectants** are used for instrument processing. Some (such as glutaraldehyde) are chemical sterilants and, given sufficient time, will destroy bacterial endospores.
2. **Low-level disinfectants** are used for cleaning surfaces, such as floors and countertops. These should not be used for instrument processing. Low-level disinfectants, such as phenols (carbolic acid—e.g., Phenol, Lysol) and quaternary ammonium compounds (such as benzalkonium chloride—e.g., Zephiran), are suitable for cleaning, but most products have few advantages over using chlorine/detergent solutions, which are less expensive and often more readily available.

Properties of chemicals used for HLD

In most settings, the only chemicals appropriate for HLD are chlorine and glutaraldehyde:

- *Chlorine* is available in liquid (sodium hypochlorite), powder (calcium hypochlorite or chlorinated lime), and tablet (sodium dichloroisocyanurate) form. Chlorine can be used for disinfection, decontamination (by soaking for 10 minutes), and HLD (by soaking for 20 minutes), but should not be used on endoscopic equipment. Because chlorine leaves a residue, rinse items thoroughly with boiled water after HLD. Chlorine can be corrosive to metals with prolonged contact and can be irritating to the skin, eyes, and respiratory tract. A new solution should be prepared daily (or whenever it becomes heavily contaminated).
- *Glutaraldehyde* (e.g., *Cidex*) is commonly used for processing equipment, such as laparoscopes, that cannot be heat sterilized. It can be used for HLD (by soaking for 20 minutes) and sterilization (by soaking for 10 hours*). Because glutaraldehyde leaves a residue, rinse items thoroughly with boiled water after HLD and with sterile water after sterilization. Glutaraldehyde can be irritating to the skin, eyes, and respiratory tract.

During HLD do *not* use:

- Hydrogen peroxide (6%), which has not been as well studied as other disinfectants. The 3% solution is suitable for disinfecting surfaces.
- Formaldehyde, which is potentially cancer causing and extremely irritating to the skin, eyes, and respiratory tract.
- Alcohol (60%–90% ethyl or isopropyl), which does not kill all viruses. However, alcohol can be used to disinfect thermometers and stethoscopes, although they should not remain soaking in an alcohol solution.
- Iodophors (e.g., Betadine), which are antiseptic preparations and not suitable for disinfection because of their low levels of iodine.
- Sporicidin, which is a glutaraldehyde-based product that has been shown to be ineffective.
- Carboic acid (e.g., Lysol, Phenol), which is a low-level disinfectant.
- Chlorhexidine gluconate with cetrimide (e.g., Savlon), chlorhexidine gluconate (e.g., Hibitane, Hibiscrub), or chloroxylenol (e.g., Dettol), which are all antiseptics.

* Note: Times apply to use of Cidex only; times for sterilization with other products may vary. Follow the manufacturer's instructions.

Steps of HLD Using Chemicals

Step 1

Decontaminate, clean, and thoroughly dry items. (Water from wet items dilutes the chemical solution, reducing its effectiveness.)

Step 2

When using glutaraldehyde: Prepare the solution as per the manufacturer's instructions or use a prepared solution, so long as it is clear (not cloudy) and has not expired. (Most glutaraldehyde solutions can be used for at least two weeks; follow the manufacturer's instructions. Ideally, use an indicator strip to determine whether the solution is effective.) After preparing the solution, put it in a clean container with a lid. Mark the container with the date the solution was prepared and the date it expires.

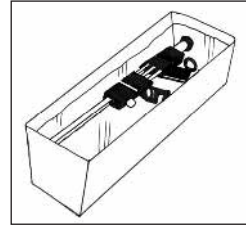

When using a chlorine solution: Follow the instructions on pages 26–27. Fresh solution should be made each day (or sooner, if the solution becomes dirty). Put the solution in a clean container with a lid.

Step 3

Open all hinged instruments and disassemble those with sliding or multiple parts (the solution must contact all surfaces in order for HLD to be achieved). Completely submerge all items so that all parts are under the surface. Place bowls and containers upright, not upside down, and fill with the solution.

Step 4

Cover the container, and allow the items to soak for 20 minutes. Do not add or remove items once timing has begun.

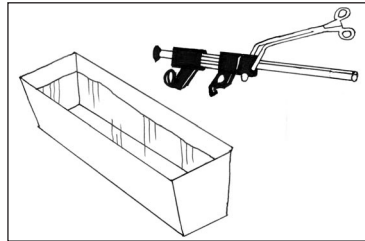

Step 5

Remove the items from the solution using dry, HLD pick-ups (lifters, cheater forceps).

Step 6

Rinse thoroughly with boiled water to remove chemical residue, which is toxic to skin and tissues.

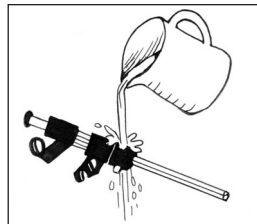

Step 7

Place the items on an HLD tray or in an HLD container and allow to air-dry before use or storage. Use items immediately or keep in a covered, dry, HLD container and use within one week.

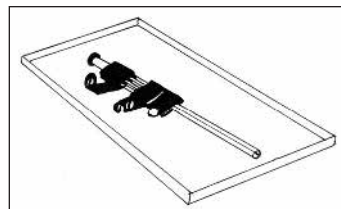

Tips for Chemical HLD:

- Items must be completely covered with solution. Open all hinged instruments and disassemble items with sliding or multiple parts.
- Soak for 20 minutes. If you forget to start timing, start at the point at which you remember.
- Do not add or remove anything once timing begins.
- Rinse items thoroughly with boiled water.

3. HLD by steaming

Items are steamed in a steamer containing one to three tiers. Steaming is the best method of HLD for gloves, and is a useful method of HLD for the cannulae used during manual vacuum aspiration. HLD of gloves by other methods is less appropriate because: 1) boiling is not recommended, since it is difficult to dry gloves properly without contaminating them. If it is necessary to HLD gloves by boiling, the gloves may be worn wet; 2) using chemicals is impractical since it is difficult to adequately rinse off the chemical residue. Whenever possible, use disposable gloves rather than reusable ones, since gloves are difficult to process.

Two-Tiered Steamer

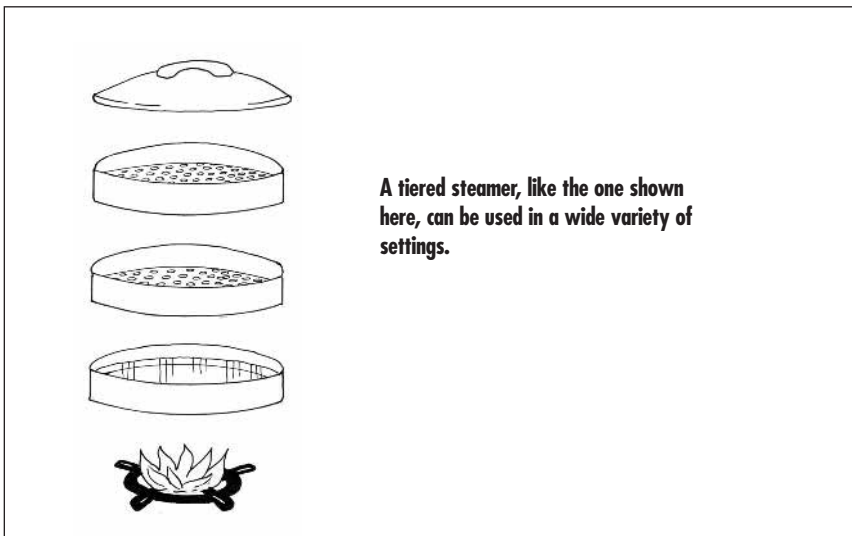

Steps of HLD by Steaming

These steps should be followed for steaming gloves and MVA cannulae. Gloves are mentioned and shown in the illustrations as an example.

Step 1

Decontaminate and clean gloves to be high-level disinfected.

Step 2

Place water in the bottom tray (which has no holes).



Step 3

Fold back the cuffs of the gloves in pairs and place the gloves in the tray(s) with holes. The number of gloves that will fit in each tray depends on the size of the tray (usually 5–15 pairs). If more than one layer of gloves is being steamed, loosely layer the gloves in a crisscross design. Gloves should not be packed tightly in the tray(s).

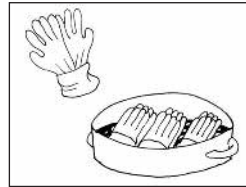

Step 4

Stack the tray(s) of gloves on top of the bottom tray.

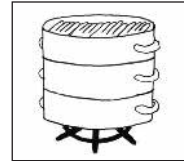

Step 5

Place the lid on the top tray and bring the water to a boil. When steam comes out between the trays, the water is boiling. Reduce the heat, but maintain the water at a rolling boil (steam should continue to come out between the trays). High heat wastes fuel and causes the water to evaporate more quickly.

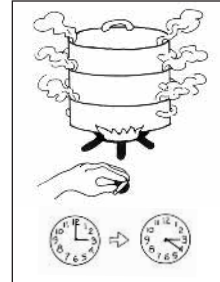

Step 6

Steam the gloves for 20 minutes. Use a timer or make sure to record the time.

Step 7

Remove each tray of gloves, shake off the excess water, and place the tray(s) on a second tray that does not have holes or contain water (a second bottom tray). (Do not place the tray containing the gloves directly on the countertop, since this may contaminate the gloves; remember, there are holes in the bottom of the tray.)

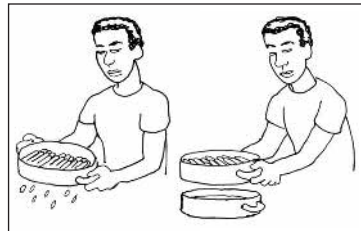

Step 8

Use the gloves immediately or allow them to dry for 4–6 hours (drying may be difficult in areas of high humidity).

Step 9

Store the gloves in a covered tray or put them in a high-level disinfected container and use within one week.

Special considerations

Special considerations must be taken when performing HLD on reusable needles and syringes, linens, and the instruments used during MVA.

Reusable needles and syringes

Whenever possible, use disposable needles and syringes rather than reusable ones, since these items are difficult to process correctly. Chemical HLD is not recommended for these items, since it is difficult to adequately rinse off the chemical residue, which may interact with or inactivate the solution being injected. Boiling is acceptable for these items.

Linens (gowns and surgical drapes)

HLD is impractical for these items; only steam sterilization should be used.

Instruments used during MVA

The cannula must be sterilized or high-level disinfected, but further processing of the syringe after decontamination and proper cleaning is not necessary because it does not come in contact with the client and is used only as a source of vacuum and as a receptacle for blood and tissue. Sterilization and HLD may actually decrease the life of the syringe, since these processes damage the syringe over time. If your facility requires processing of the syringe, use chemical HLD and be sure that the syringe is completely submerged and the barrel filled with the solution.

HLD through boiling, chemicals, or steaming may be used for the cannula. Research has shown that the cannula does not need to be submerged in the water for boiling to be effective; however, the boiler must be kept covered during processing.

Step 4 Storage

Items should be used or properly stored immediately after processing so that they do not become contaminated. Proper storage is as important as proper decontamination, cleaning, and sterilization or HLD. If items are not stored properly, all the effort and supplies used to properly process them will have been wasted, and the items may be contaminated.

Specific instructions for proper storage depend on whether sterilization or HLD has been performed, the method used, and whether the items are wrapped or unwrapped. (In this booklet, any method-specific instructions for storage have been noted as the last step in the sterilization or HLD process.)

Note: No matter what method is used, do not store instruments or other items (such as scalpel blades and suture needles) in solutions: always

store them dry. Microorganisms can live and multiply in both antiseptic and disinfectant solutions, and items left soaking in contaminated solutions can lead to infections in clients. In addition, antiseptic solutions should *not* be used to process objects.

Remember: If an item comes in contact with persons, surfaces, dust particles, insects, or any item that is not sterile or HLD, the item must be considered to be contaminated. Because of the high risk of contamination, unwrapped sterile or HLD items should be used immediately or kept in a covered, sterile or HLD container for no longer than one week after processing.

Storage of wrapped, sterile items

The length of time a wrapped, sterile item is considered sterile depends on whether or not a contaminating event occurs—not necessarily on how long the item has been stored. The shelf life of a wrapped item is affected by a number of factors, including:

- The type of packing material used
- The number of times the pack is handled
- The number of people who handle the pack
- The cleanliness, humidity, and temperature of the storage area
- Whether the packs are stored on open or closed shelves
- Whether dust covers (such as sealed plastic bags) are used

For optimal storage, place sterile packs in closed cabinets in areas that are not heavily trafficked, have moderate temperatures, and are dry or of low humidity. Under optimal storage conditions and with minimal handling, properly wrapped items can be considered sterile as long as they remain intact and dry.

Storage time and the handling of sterile packs should be kept to a minimum, since the likelihood of contamination increases over time and with increased handling. When in doubt about the sterility of a pack, consider it to be contaminated and resterilize the item before use.

Organizing an area for instrument processing

Remember, the objectives of processing are:

- To remove as many microorganisms as possible so that microorganisms are not transmitted to clients during clinical procedures
- To reduce the risk of infection to staff by eliminating harmful microorganisms on items that have been in contact with a client's fluids or tissues during clinical procedures

When processing items, activity patterns should be established so that soiled items never cross paths with clean, sterile, or HLD items.

It is ideal to have separate rooms—one for receiving and cleaning items and another for sterilization, HLD, and storage. However, in many settings, this is not possible. When only one room is available for processing, it should be arranged so that activities and objects flow in an organized fashion from receiving to storage. It is necessary to have at least one sink in processing areas (though having two sinks is preferred), sufficient counter-top space for receiving dirty items and for drying and packaging clean items, and storage space (preferably closed cabinets).

Separate Rooms for Processing Instruments and Other Items

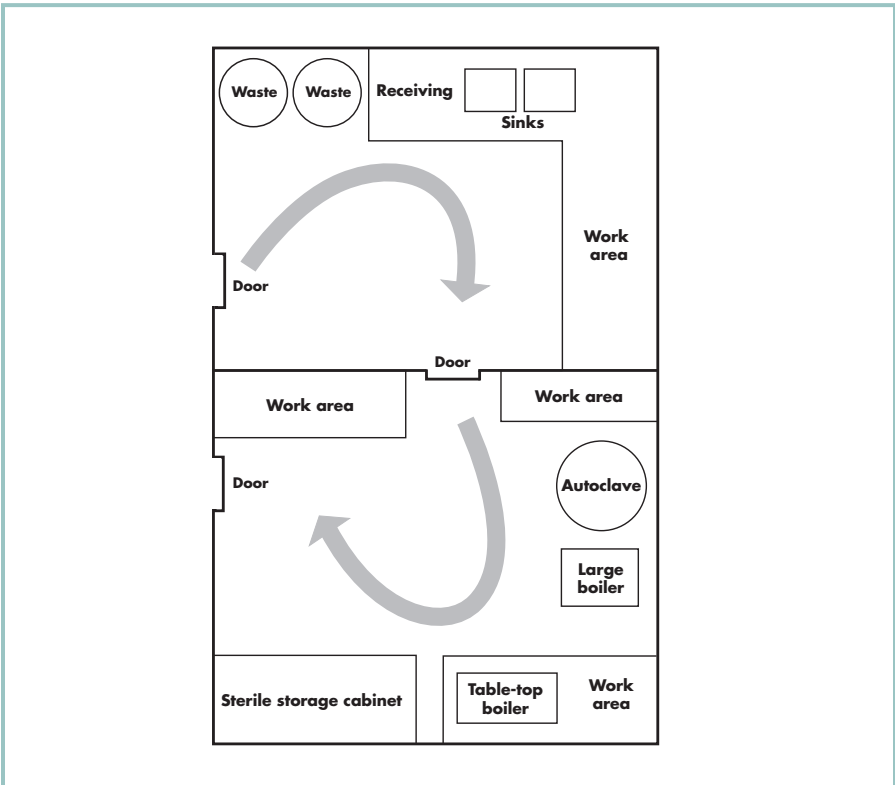

Single Room for Processing Instruments and Other Items

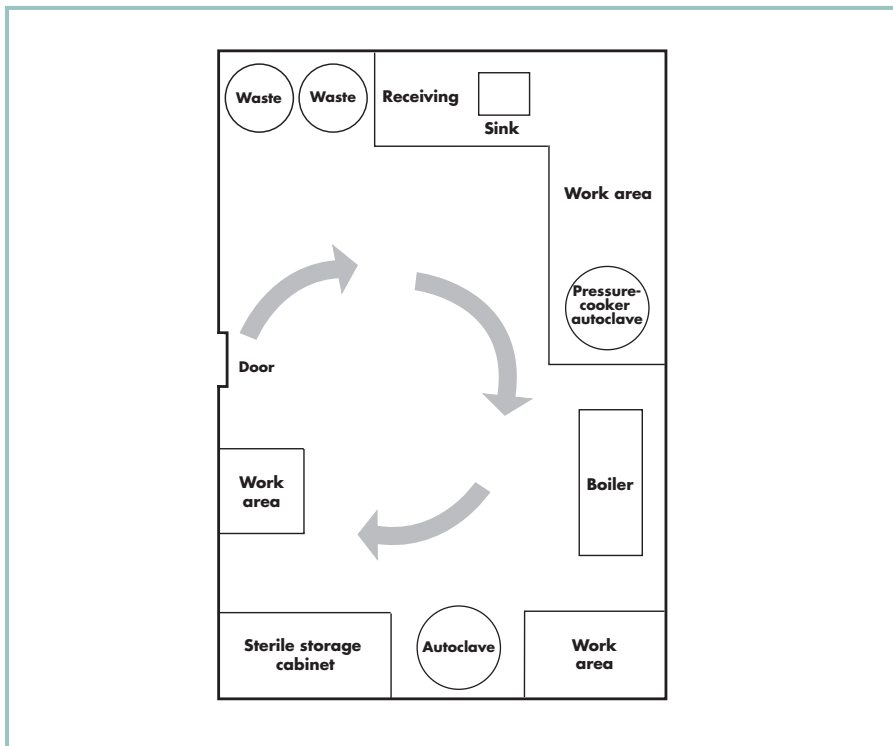

Tips for Organizing a Processing Area:

- Educate staff about the need to keep clean and sterile/HLD items from coming into contact with soiled items.
- Designate and label processing areas, particularly when only one room is available.
- Enclose processing rooms to minimize dust and eliminate insects.
- If possible, ensure access to two sinks or basins with a clean water supply (one sink for cleaning, one for rinsing).
- Store clean, sterile, and HLD instruments and other items on shelves with doors to minimize the amount of dust and debris falling onto the packaging.
- Avoid using cardboard boxes for storage, as they can harbor insects and shed dust and debris.
- Remove supplies from all shipping cartons and boxes before bringing them into an operating theater, procedure room, or clean work area.

Housekeeping and Waste Disposal

The general cleanliness and hygiene of a facility are vital to the health and safety of staff, clients, visitors, and the community at large. Good housekeeping and waste disposal practices are the foundation of good infection prevention. Housekeeping and waste disposal staff are at a high risk of infection because they are exposed to blood, other body fluids, used sharps, and other contaminated objects as a routine part of their jobs.

General housekeeping guidelines

Although certain areas of the clinic require special housekeeping procedures, the following list applies to all parts of the clinic:

- Develop and post cleaning schedules where all housekeeping staff can see them. Make sure that cleaning schedules are closely maintained.
- Wear gloves (preferably thick utility gloves) when cleaning.
- To reduce the spread of dust and microorganisms, use a damp or wet mop or cloth for walls, floors, and surfaces instead of dry-dusting or sweeping.
- Scrubbing is the most effective way to remove dirt and microorganisms. Scrubbing should be a part of every cleaning procedure.
- Wash surfaces from top to bottom so that debris falls to the floor and is cleaned up last. Clean the highest fixtures first and work downward—for example, clean ceiling lamps, then shelves, then tables, and then the floor.
- Change cleaning solutions whenever they appear to be dirty. A solution is less likely to kill infectious microorganisms if it is heavily soiled.

Cleaning solutions

Three types of cleaning solutions are used during housekeeping at a health facility. It is essential that housekeeping staff understand the different types of cleaning agents and how each should be used:

1. Plain detergent and water

This is used for low-risk areas and general cleaning tasks. Detergents remove dirt and organic material and dissolve or suspend grease, oil, and other matter for easy removal by scrubbing.

2. Disinfectant (0.5% chlorine solution)

Disinfectants rapidly kill or inactivate infectious microorganisms during the cleaning process. Disinfectants are used to clean up spills of blood or other body fluids.

3. Disinfectant cleaning solution

This solution, which contains a disinfectant, detergent, and water, is used for cleaning areas that may be contaminated with infectious materials (such as operating theaters, procedure rooms, latrines, and sluice rooms). The solution must contain both a disinfectant and a detergent. Disinfectants rapidly kill or inactivate infectious microorganisms during the cleaning process, while detergents remove dirt and organic material, which cannot be done by water or disinfectants alone.

In most settings, a 0.5% chlorine solution made from locally available bleach is the cheapest disinfectant, but alternatives include commercial disinfectants that contain 5% carbolic acid (such as Phenol or Lysol) or quaternary ammonium compounds. For information about how to make a 0.5% chlorine solution, see pages 26–27.

To make a disinfectant cleaning solution:

Prepare a 0.5% chlorine solution following the instructions on page 27 (or obtain any disinfectant that contains 5% carbolic acid, such as Phenol or Lysol, or quaternary ammonium compounds). Add some detergent and mix. Continue adding detergent until the solution is mildly sudsy.

Cleaning procedures for different clinic areas

Low-risk areas (waiting rooms, administrative areas)

These are the areas that are usually not contaminated with infectious microorganisms, and the risk of infection is minimal. Routine cleaning—the kind of cleaning you would do in your home—is usually good enough for these areas. In general, clean these areas once a week (or whenever they appear to be dirty) with a cloth or mop dampened with detergent and water. Vacuum carpeted areas once a week and shampoo as needed. In unusual circumstances in which contamination occurs in these areas, use the appropriate practices described below.

Caution:

Chlorine solutions should never be mixed with cleaning products that contain ammonia, ammonium chloride, or phosphoric acid. Combining these chemicals will result in the release of a chlorine gas, which can cause nausea, eye irritation, tearing, headache, and shortness of breath. These symptoms may last for several hours. If you are exposed to an unpleasantly strong odor following the mixing of a chlorine solution with a cleaning product, leave the room or area immediately until the fumes have cleared completely.

Toilets, latrines, and sluice rooms

These areas are usually heavily contaminated and should be cleaned daily—or more often if traffic in your facility is high. Use different supplies to clean these areas than the supplies you use for cleaning client-care areas.

Cleaning Schedule: Toilets, Latrines, and Sluice Rooms

Task	Schedule
Clean walls	Wipe with a disinfectant cleaning solution each day (or more often, if necessary).
Clean ceilings	Wipe with a disinfectant solution each week (or more often, if necessary).
Clean counters and other surfaces	Wipe with a cloth saturated with a disinfectant cleaning solution each day (or more often, if necessary).
Clean floors	Use a mop and a disinfectant cleaning solution each day (or more often, if necessary).
Clean sinks and toilets/latrines	Scrub with a disinfectant cleaning solution and rinse with clean water each day (or more often, if necessary).
Empty waste containers	Each day (or more often, if necessary)
Clean waste containers	Scrub to remove soil or organic material with a disinfectant cleaning solution each day (or more often, if necessary).

Client-care areas (operating theaters, procedure rooms, laboratories, areas where instruments are cleaned and processed)

These areas must be cleaned with special care using a disinfectant cleaning solution. In these areas, there is a greater potential for contamination with infectious materials and more of a concern about potential infection transmission to both clients and clinic staff.

Cleaning Schedule: Client-Care Areas

<p><i>At the beginning of each day</i></p>	<p>Clean horizontal surfaces—operating/procedure tables, examination couches, chairs, trolley tops or Mayo stands, lamps, counters, and office furniture—with a cloth dampened with water, and clean floors with a mop dampened with water to remove dust and lint that have accumulated overnight.</p>
<p><i>Between clients</i></p>	<ul style="list-style-type: none"> • Clean operating/procedure tables, examination couches, trolley tops or Mayo stands, counters, lamps, and any other potentially contaminated surfaces in operating theaters and procedure rooms with a cloth dampened with a disinfectant cleaning solution. Alternatively, spray the solution onto the surfaces, using a spray bottle, and wipe with a cloth dampened with water. • Clean spills of blood or other body fluids with a 0.5% chlorine solution immediately. • Clean visibly soiled areas of the floor, walls, or ceiling with a mop or cloth dampened with a disinfectant cleaning solution. • Put waste in a leakproof container, and empty the container when it is $\frac{3}{4}$ full.
<p><i>At the end of each clinic session or day</i></p>	<ul style="list-style-type: none"> • Wipe down all surfaces—including counters, tables, sinks, lights, door handles/plates, and walls—with a cloth dampened with a disinfectant cleaning solution or spray the solution onto the surface using a spray bottle and wipe them down. Remember to wipe from top to bottom. Pay particular attention to operating/procedure tables, making sure to clean the sides, base, and legs thoroughly. Rinse sinks with clean water after cleaning. • Clean the floors with a mop soaked in a disinfectant cleaning solution. • Check sharps-disposal containers and remove and replace them if they are $\frac{3}{4}$ full. • Remove medical or hazardous chemical waste, making sure to burn or bury it as soon as possible to limit contact with potentially infectious waste. (This is covered in detail on pages 62–68.) • Wash waste containers with a disinfectant cleaning solution and rinse with water.
<p><i>Each week</i></p>	<ul style="list-style-type: none"> • Clean ceilings with a mop dampened with a disinfectant cleaning solution.

Cleaning up spills

Clean up spills of potentially infectious fluids immediately. Besides preventing the spread of infection, prompt removal also prevents accidents.



When cleaning up spills:

- Always wear gloves.
- If the spill is small, wipe it with a cloth that has been saturated with a disinfectant (0.5% chlorine) solution.
- If the spill is large, cover (flood) the area with a disinfectant (0.5% chlorine) solution, mop up the solution, and then clean the area with a disinfectant cleaning solution.
- Do not simply place a cloth over the spill for cleaning up later; someone could easily slip and fall on it and be injured.

Remember:

Contaminated equipment spreads, rather than reduces, microorganisms in the environment. Supplies and equipment used for cleaning also need to be cleaned. Equipment (such as mops, buckets, and cloths) should be decontaminated with a disinfectant (0.5% chlorine) solution, cleaned in detergent and water, rinsed in clean water, and dried before reuse.

Ineffective practices

Two housekeeping practices—fumigation and the use of ultraviolet (UV) light—are common in many health facilities, particularly in some parts of the developing world, but should be eliminated. These practices are time-consuming, waste valuable resources, and do not decrease the risk of infection in your facility.

1. Fumigation (also called “disinfectant fogging”)

Fumigation with formalin, formaldehyde, or paraformaldehyde is an ineffective method of reducing the risk of infection. It is a perfect example of a practice that is not based on scientific findings.

Besides being ineffective, these agents are toxic and irritating to the eyes and mucous membranes. Fumigation is time-consuming and makes rooms unavailable for use, often leading to disruption of services or unnecessary inconvenience to clients and staff. Thorough cleaning with a disinfectant cleaning solution and scrubbing should be used instead of fumigation.

2. Ultraviolet (UV) light

In general, this is neither practical nor cost-effective. In the largest and best-designed scientific study on this topic, no decrease was shown in the surgical-site infection rate when UV light was used. Although UV light does have some uses in specialized sites (such as tissue culture laboratories), UV light is unsatisfactory for general use in health care facilities because:

- The killing ability of UV light decreases sharply: 1) if relative humidity is greater than 60%–70%; 2) if dust is present (in the air, on surfaces, or on the bulb itself); and 3) with increasing distance from the lamp.
- UV light does not penetrate most substances (including fluids and organic matter, such as mucous) and will therefore kill only microorganisms directly on the surface that are exposed to the UV light.
- The intensity of UV light needed to effectively kill microorganisms is damaging to humans. Prolonged exposure can lead to eye or skin irritation.
- UV lighting fixtures are expensive to install and maintain. Regular servicing, including removing dust from the bulbs, is required.

Cleaning by scrubbing with a disinfectant cleaning solution is the most efficient and cost-effective way to clean potentially contaminated areas in your facility.

Handling and disposal of medical waste

All staff have a responsibility to dispose of waste in a manner that poses minimal hazard to clients, visitors, other health care workers, and the community. Anyone who handles contaminated waste—from the time it is thrown out by a service provider to even after it reaches the site of final disposal—is at risk of infection or injury.

Proper disposal:

- Minimizes the spread of infections and reduces the risk of accidental injury to staff, clients, visitors, and the local community
- Helps provide an aesthetically pleasing atmosphere
- Reduces odors
- Attracts fewer insects and animals
- Reduces the likelihood of contamination of the soil or ground water with chemicals or microorganisms

A large percentage of staff (including nurses, midwives, nursing aides, and cleaning and maintenance staff) report having experienced waste-related injuries and infections. Sharps pose the greatest risk and can cause injury and transmission of serious infections, including HIV and

hepatitis B. If possible, all staff at risk of waste-related injury should be vaccinated against hepatitis B.

Improper disposal of waste is also one of the greatest threats to members of the community. In many low-resource settings, scavenging of medical waste is a significant problem. Not only are scavengers at risk of injury and infection themselves, but this practice can also put clients and the local community at risk when scavenged waste, such as syringes and needles, is reused.

Three kinds of waste

There are three kinds of waste generally found in health facilities: general waste, medical waste, and hazardous chemical waste. It is important to dispose of all kinds of waste properly, but improper disposal of medical and hazardous chemical waste poses the most immediate health risk to the community.

1 General waste

Nonhazardous waste that poses no risk of injury or infections. This is similar in nature to household trash. Examples include paper, boxes, packaging materials, bottles, plastic containers, and food-related trash.

2 Medical waste

Material generated in the diagnosis, treatment, or immunization of clients, including:

- Blood, blood products, and other body fluids, as well as materials containing fresh or dried blood or body fluids, such as bandages and surgical sponges
- Organic waste such as human tissue, body parts, placentas, and products of conception
- Sharps (used or unused), including hypodermic and suture needles, scalpel blades, blood tubes, pipettes, and other glass items that have been in contact with potentially infectious materials (such as glass slides and coverslips)

3 Hazardous chemical waste

Chemical waste that is potentially toxic or poisonous, including cleaning products, disinfectants, cytotoxic drugs, and radioactive compounds.

Note: Although both medical and chemical waste pose dangers, the focus of this booklet is on disposal of potentially infectious medical waste.

Disposal of cytotoxic drugs and radioactive waste requires special consideration outside the scope of this booklet: if your facility uses these materials, consult local experts for guidance on appropriate handling and disposal.

Creating a waste-management plan

Every health facility—whether a large hospital, a doctor’s office, or a small health post—should develop a medical waste-management plan and should designate a staff member to coordinate the management of medical waste.

There are four components to a waste-management plan:

1. **Sorting:** Separating waste by type at the place where it is generated
2. **Handling:** Collecting and transporting waste within the facility
3. **Interim storage:** Storing waste within the facility until it can be disposed of
4. **Final disposal:** Eliminating solid medical waste, liquid medical waste, sharps, and hazardous chemical waste from the health facility

1. Sorting

Only a small percentage of the waste generated by a health care facility is medical waste that must be handled specially to reduce the risk of infections or injury.

Sorting the waste at the point where it is generated can conserve resources by greatly reducing the amount of waste that needs special handling. Poor separation leads to large amounts of trash that must be handled specially—which can overwhelm the disposal system, lead to improper disposal of medical waste, and put everyone at risk.

Sorting sharps

Needles and other sharps pose the greatest risk of

Tips for Sorting Waste:

Medical and general waste should be put in the appropriate waste containers. To help the staff use containers correctly:

- ☛ **Always keep separate containers in convenient places wherever both general and medical waste are generated.**
- ☛ **Use colored plastic containers, painted drums, or easily readable labels to help distinguish between general and medical waste containers. For example, paint the containers used for medical waste red or use red plastic bags, if available.**
- ☛ **Place sharps containers in convenient places so that staff do not have to walk across the room (or farther) carrying used sharps.**

injury, and should be disposed of in special sharps containers, such as heavy cardboard boxes, tin cans with lids, or plastic bottles. (For more information on the proper handling of sharps, see pages 21–22.)

2. Handling

Staff should handle medical waste as little as possible before storage and disposal. The more waste is handled, the greater the chance for accidents. Special care must be taken when handling used needles and other sharps, which pose the greatest risk of accidental injury and infection.

Emptying waste containers

Waste containers that are too full also present opportunities for accidents. Waste should be removed from operating theaters, procedure rooms, and sluice rooms before the containers become completely full. At the very least, these containers should be emptied once a day. Dispose of sharps containers when they are $\frac{3}{4}$ full. (When sharps-disposal containers become too full, people may push sharps into the container, causing injury.)

3. Interim storage

If possible, final disposal of waste should take place immediately, but it is often more practical to store waste briefly in your facility before final disposal. Interim storage should be short-term—usually waste should be stored only for a few hours before disposal. Waste should never be stored in your facility for more than one or two days.

If it is necessary to store medical waste on-site before final disposal: place waste in a closed area that is minimally accessible to staff, clients, and visitors. As few people as possible should come into contact with stored medical waste.

Tips for Handling Waste:

- ☛ **Handle medical waste as little as possible.**
- ☛ **Remove waste from operating theaters, procedure rooms, and sluice rooms while the containers are still partially empty—or at least once a day.**
- ☛ **Never put your hands into a container that holds medical waste.**
- ☛ **Do not collect medical waste from client-care areas by emptying it into open carts or wheelbarrows, as this may lead to spills and contamination of the surroundings, may encourage scavenging of waste, and may increase the risk of injury to staff, clients, and visitors.**

Remember:

Contaminated medical waste poses serious health threats to the community. Never store medical waste in open containers and never throw waste into an open pile. All containers should have lids to prevent exposure to waste, spillage, or access by insects, rodents, and other animals.

4. Final disposal

General waste—like household trash—can be taken to the regular community waste-disposal point for final collection and disposal. This section discusses the final disposal of:

- Solid medical waste
- Liquid medical waste
- Contaminated sharps

Solid medical waste

Always wear heavy utility gloves and shoes when handling or transporting medical waste of any kind. Solid medical waste should be disposed of on the premises if at all possible; this allows staff who understand the risks involved to supervise the disposal process. There are three options for the disposal of solid medical waste: burning waste, burying waste, and transporting waste to an off-site disposal site.

Burning. Burning is the best option, since high temperatures destroy microorganisms and reduce the amount of waste. Burning in an incinerator or oil drum is recommended. Open burning is not recommended because it causes scattering of waste, is dangerous, and is unattractive. However, if open burning must be done, carry the waste to the site just before burning, and burn it in a small, designated area. Remain with the fire until it is completely out.

Building a drum incinerator.

In general, a drum incinerator is only useful for small, usually rural, facilities that do not have large quantities of medical waste. If your facility is large, it is more efficient to build or install an incinerator large enough to accommodate all of your facility's waste-disposal needs.

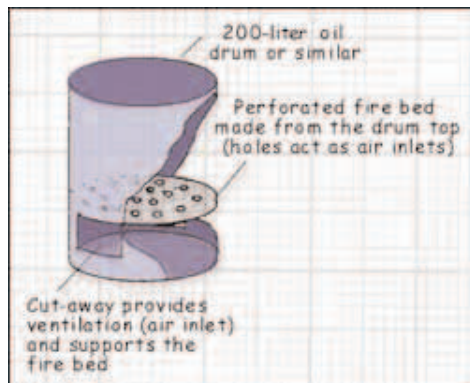

When using your drum incinerator:

- Choose a place that is downwind from the clinic to prevent smoke and odors from coming into the clinic.
- Make sure there are sufficient air inlets on the side of the oil drum and bottom of the fire bed for efficient burning.
- Place the incinerator on hardened earth or a concrete base to prevent grass from catching fire during the burning process.
- Burn only medical waste. Use a regular community disposal site for general waste. This will conserve both time and resources.
- Treat the ash as general waste. Bury or otherwise dispose of it in a designated area.

Medical waste may not burn easily, especially if it is wet. Add kerosene to make the fire hot enough to burn all waste. Be sure to add the kerosene *before* starting the fire—adding kerosene after the fire has started might cause an explosion.

Burying. On-site burial is the next best option. To use burial, you must have space for a pit big enough for all the waste generated at the site. The pit should be surrounded by a fence or wall to limit access to it and to prevent scavenging of waste.

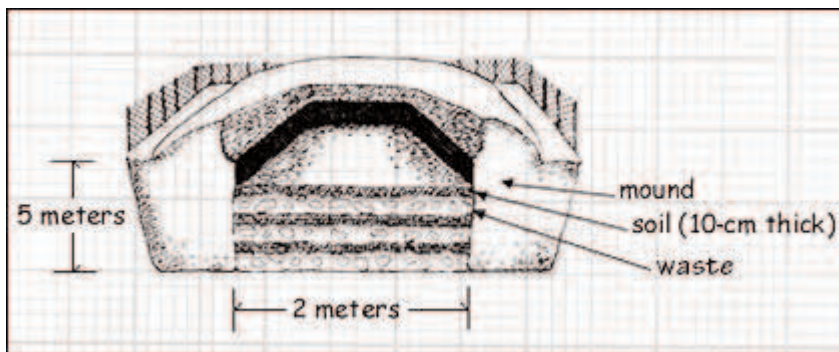

Building and using a waste-burial pit.

- Choose an appropriate site that is at least 50 meters away from any water source to prevent contamination of the water source. The site should have proper drainage, be located downhill from any wells, be free of standing water, and be in an area that does not flood. The site should not be located on land that will be used for agriculture or development.
- Dig a pit 1 to 2 meters wide and 2 to 5 meters deep. The bottom of the pit should be 1.8 meters above the water table. Consult your local water engineer/water authority for information about the location of the water table.

- Fence in the area to keep out animals, scavengers, and children.
- Keep waste covered. Every time waste is added to the pit, cover it with a 10 to 30 cm layer of soil.
- Seal the pit. When the level of waste reaches to within 30 to 50 cm of the surface of the ground, fill the pit with dirt, seal it with concrete, and dig another pit.

Transporting. If neither burning nor burial on-site is possible, the waste must be transported for off-site disposal. If waste will be handled during transport by nonfacility staff (such as municipal trash removers), they must be educated about the cautions and risks regarding medical waste. Transport to an open community dump is the least desirable alternative. Open dumps increase the community's risk of exposure to infectious microorganisms because: 1) they facilitate the spread of infections by flies, rodents, and other animals that come in contact with medical waste; 2) people may easily come in contact with waste in open dump sites—for example, local children may play near the dump site; and 3) they encourage scavenging.

Liquid medical waste

Always wear heavy utility gloves and shoes when handling or transporting liquid medical waste of any kind. When carrying or disposing of liquid medical waste, be careful to avoid splashing the waste on yourself, on others, or on the floor and other surfaces.

- Handle cleaning solutions and disinfectants such as glutaraldehyde in the same way as liquid medical waste.
- Carefully pour liquid waste down a sink, drain, flushable toilet, or latrine. If this is not possible, bury it in a pit along with solid medical waste.
- Before pouring liquid waste down a sink, drain, or toilet, consider where the drain empties. It is hazardous for liquid medical waste to run through open gutters that empty onto the grounds of the facility.
- Rinse the sink, drain, or toilet thoroughly with water to remove residual waste—again avoid splashing. Clean these areas with a disinfectant cleaning solution at the end of each day, or more frequently if heavily used or soiled.
- Decontaminate the container that held the liquid waste by filling it with or soaking it for 10 minutes in a 0.5% chlorine solution before washing.
- Wash your gloved hands after handling liquid waste before removing the gloves.

Sharps

Needlesticks and punctures involving sharps are the number-one cause of waste-related accidents for staff in health facilities. To reduce the risk of needlesticks, do not recap, bend, cut, or break needles or try to remove the needles from the syringe before disposal.

Although burning is the best way to dispose of medical waste, sharps are not destroyed by burning, except in large industrial incinerators. If an industrial incinerator is not available, sharps can be rendered harmless by placing needles, plastic syringes, and scalpel blades in a metal container and then, when the container is three-quarters full, pouring in fuel and igniting and burning it until the fire goes out on its own. When this is done, the plastic syringes will melt and, when cool, become a solid block of plastic, with the sharps embedded within the block. The block can then be buried in the type of burial pit used for solid medical waste. If it is not possible to bury all medical waste on-site, sharps should be given priority for burial, since they pose the biggest risk of injury and infections.

References

- Alter, M. J., Ahtone, J., and Maynard, J. E. 1983. Hepatitis B virus transmission associated with a multiple-dose vial in a hemodialysis unit. *Annals of Internal Medicine* 99:330–333.
- Antimicrobial prophylaxis in surgery. 1995. *Medical Letter on Drugs and Therapeutics* 37(957):79–82.
- Association of Operating Room Nurses, Inc. 1996. Inservice Education Module: Aseptic Technique. Denver, CO.
- Association of Operating Room Nurses, Inc. 1997. *Standards, recommended practices, and guidelines*. Denver, CO.
- Atkinson, L. J., and Kohn, M. L. 1986. *Introduction to operating room technique*, 6th ed. New York: McGraw-Hill.
- Belkin, N. L. 1997. Use of scrubs and related apparel in health care facilities. *American Journal of Infection Control* 25:401–404.
- Block, S. S. (ed.). 1991. *Disinfection, sterilization, and preservation*, 4th ed. Philadelphia: Lea and Febiger.
- Borghans, J. G. A., and Stanford, J. L. 1973. *Mycobacterium chelonae* in abscesses after injection of diphtheria-pertussis-tetanus-polio vaccine. *American Review of Respiratory Disease* 107:1–8.
- Centers for Disease Control. 1970. *Isolation techniques for use in hospitals*. Washington, DC: U.S. Government Printing Office.
- Centers for Disease Control and Prevention. 1995. Hepatitis surveillance report no. 56. Atlanta.
- Chou, T. 1996. Environmental services. In *APIC infection control and applied epidemiology: Principles and practice*, ed. by R. N. Olmsted. St. Louis: Mosby-Year Book.
- Coad, A. (ed.) 1994. *Managing medical wastes in developing countries: Report of a consultation on medical wastes management in developing countries*, WHO, Geneva, September 1992. Geneva: World Health Organization.
- Cokendolpher, J. C., and Haukos, J. F. 1996. *The practical application of disinfection and sterilization in health care facilities*. Chicago: American Hospital Association.
- Cruse, P. J. E., and Foord, R. 1980. The epidemiology of wound infections: A 10-year prospective study of 62,939 wounds. *Surgical Clinics of North America* 6:27–39.
- DeCastro, M. G., Fauerbach, L., and Masters, L. 1996. Aseptic techniques. In *APIC infection control and applied epidemiology: Principles and practice*, ed. by R. N. Olmsted. St. Louis: Mosby-Year Book.
- Earl, A. 1996. Operating room. In *APIC infection control and applied epidemiology: Principles and practice*, ed. by R. N. Olmsted. St. Louis: Mosby-Year Book.
- Eiseman, E. R. 1996. *Managing change: A practical guide for supervisors*. New York: AVSC International and the Ministry of Health/Vietnam.

- Favero, M. S., and Bond, W. W. 1991. Chemical disinfection of medical and surgical materials. In *Disinfection, sterilization, and preservation*, 4th ed., ed. by S. S. Block. Philadelphia: Lea and Febiger.
- Garner, J. S., and Favero, M. S. 1985. *Guidelines for handwashing and hospital environmental control*. Washington, DC: U.S. Government Printing Office.
- Garner, J. S., and the Hospital Infection Control Practices Advisory Committee. 1996. Guideline for isolation precautions in hospitals. *Infection Control and Hospital Epidemiology* 17(1):53–80.
- Garner, J. S., and Simmons, B. P. 1983. CDC guideline for isolation precautions in hospitals. Section 3: Techniques and recommendations for isolation precautions. *Infection Control* 4:256.
- Gerding, D. E. 1996. Antimicrobial treatment. In *APIC infection control and applied epidemiology: Principles and practice*, ed. by R. N. Olmsted. St. Louis: Mosby-Year Book.
- Greaves, W. L., et al. 1982. Streptococcal abscesses following diphtheria-tetanus toxoid-pertussis vaccination. *Pediatric Infectious Disease Journal* 1:388–390.
- Gröschel, D. H. M., and Pruett, T. L. 1991. Surgical antisepsis. In *Disinfection, sterilization, and preservation*, 4th ed., ed. by S. S. Block. Philadelphia: Lea and Febiger.
- Halbwachs, H. 1994. Solid waste disposal in district health facilities. *World Health Forum* 15:363–367.
- Hlady, W. G., et al. 1993. Patient-to-patient transmission of hepatitis B in a dermatology practice. *American Journal of Public Health* 83:1689–1693.
- Holmes, K. K., et al. (eds.) 1990. *Sexually transmitted diseases*, 3rd ed. New York: McGraw-Hill.
- Holzheimer, R. G., et al. 1997. The challenge of postoperative infections: Does the surgeon make a difference? *Infection Control and Hospital Epidemiology* 18(6):449–456.
- Howard, R. J. 1994. Surgical infections. In *Principles of surgery*, 6th ed., ed. by S. I. Schwartz, G. T. Shires, and F. C. Spence. New York: McGraw-Hill.
- Institute for Development Training (IDT) and the AIDS Unit, International Planned Parenthood Federation (IPPF). 1988. Infection control in your clinic: Part two—Handwashing and using gloves. In *A review of infection control for family planning clinics*. Chapel Hill, NC.
- INTRAH. 1996. Appendix 11: Infection prevention in FP/MCH clinics. In *Guidelines for clinical procedures in family planning: A reference for trainers*. Chapel Hill, NC.
- Joslyn, L. J. 1991. Sterilization by heat. In *Disinfection, sterilization, and preservation*, 4th ed., ed. by S. S. Block. Philadelphia: Lea and Febiger.
- Koo, D., et al. 1989. Epidemic keratoconjunctivitis in a university medical center ophthalmology clinic; need for re-evaluation of the design and disinfection of instruments. *Infection Control and Hospital Epidemiology* 10:547–552.

- Kothari, T., et al. 1977. *Pseudomonas cepacia* septic arthritis due to intra-articular injections of methylprednisolone. [Letter] *Canadian Medical Association Journal* 116:1230–1232.
- Larson, E. L. 1996. Hand washing and skin preparation for invasive procedures. In *APIC infection control and applied epidemiology: Principles and practice*, ed. by R. N. Olmsted. St. Louis: Mosby-Year Book.
- Larson, E. L., and the 1992, 1993, and 1994 APIC Guidelines Committee. 1995. APIC guideline for handwashing and hand antisepsis in health care settings. *American Journal of Infection Control* 23:251–269.
- Lidwell, O. M. 1994. Ultraviolet radiation and the control of airborne contamination in the operating room. *Journal of Hospital Infection* 28:245–248.
- Loeb, M. B., et al. 1997. A randomized trial of surgical scrubbing with a brush compared to antiseptic soap alone. *American Journal of Infection Control* 25:11–15.
- Lundberg, M., Wrangsjö, K., and Johansson, S. G. 1997. Latex allergy from glove powder—An unintended risk with the switch from talc to cornstarch? *Allergy* 52(12):1222–1228.
- McDonald, L. L. 1996. Laundry. In *APIC infection control and applied epidemiology: Principles and practice*, ed. by R. N. Olmsted. St. Louis: Mosby-Year Book.
- Muscarella, L. F. 1996. High-level disinfection or “sterilization” of endoscopes? *Infection Control and Hospital Epidemiology* 17:183–187.
- Nakashima, A. K., et al. 1987. Epidemic septic arthritis caused by *Serratia marcescens* and associated with a benzalkonium chloride antiseptic. *Journal of Clinical Microbiology* 25:1014–1018.
- National Academy of Sciences—National Research Council. 1964. Postoperative wound infections: the influence of ultraviolet irradiation of the operating room and of various other factors. *Annals of Surgery*. Suppl., 160: 1–192.
- Palmer, M. B. 1984. *Infection control: A policy and procedure manual*. Philadelphia: W. B. Saunders Co.
- Pearson, M. L., and the Hospital Infection Control Practices Advisory Committee. 1996. Guideline for prevention of intravascular device-related infections. Part I: Intravascular device-related infections: An overview. [Special Communication] *American Journal of Infection Control* 24:262–293.
- Pegues, D. A., et al. 1993. Outbreak of *Pseudomonas cepacia* bacteremia in oncology patients. *Clinical Infectious Diseases* 16:407–411.
- Perkins, J. J. 1983. *Principles and methods of sterilization in health sciences*, 2nd ed. Springfield, IL: Charles C. Thomas.
- Poole, C. J. M. 1997. Hazards of powdered surgical gloves. [Commentary] *Lancet* 350 (Oct. 4): 973–974.
- Rogers, B. 1997. Health hazards—in nursing and health care: An overview. *American Journal of Infection Control* 25:248–261.
- Roy, M. C., and Perl, T. M. 1997. Basics of surgical-site infection surveillance. *Infection Control and Hospital Epidemiology* 18(9):659–668.

- Rutala, W. A. 1984. Antiseptics and disinfectant—Safe and effective? *Infection Control* 5(5):215–218.
- Rutala, W. A. 1993. Disinfection, sterilization and waste disposal. In *Prevention and control of nosocomial infections*, 2nd ed., ed. by R. P. Wenzel. Baltimore: Williams and Wilkins.
- Rutala, W. A., and the 1994, 1995, and 1996 APIC Guidelines Committee. 1996. APIC guideline for selection and use of disinfectants. *American Journal of Infection Control* 24:313–342.
- Rutala, W. A., and Shafer, K. M. 1996. General information on cleaning, disinfection, and sterilization. In *APIC infection control and applied epidemiology: Principles and practice*, ed. by R. N. Olmsted. St. Louis: Mosby-Year Book.
- Schaffer, S. D., et al. 1996. *Pocket guide to infection prevention and safe practice*. St. Louis: Mosby-Year Book.
- Schmidt, E. A. 1996. Medical waste management. In *APIC infection control and applied epidemiology: Principles and practice*, ed. by R. N. Olmsted. St. Louis: Mosby-Year Book.
- Scott, E. M., and Gorman, S. P. 1991. Glutaraldehyde. In *Disinfection, sterilization, and preservation*, 4th ed., ed. by S. S. Block. Philadelphia: Lea and Febiger.
- Seropian, R., and Reynolds, B. 1971. Wound infections after preoperative depilatory versus razor preparation. *American Journal of Surgery* 121:251–254.
- Shechmeister, I. L. 1991. Sterilization by ultraviolet irradiation. In *Disinfection, sterilization, and preservation*, 4th ed., ed. by S. S. Block. Philadelphia: Lea and Febiger.
- Solter, C. 1997. *Comprehensive reproductive health and family planning training curriculum, Module 2: Infection prevention*. Watertown, MA: Pathfinder International.
- Stetler, H. C., et al. 1985. Outbreaks of group A streptococcal abscesses following diphtheria-tetanus toxoid-pertussis vaccination. *Pediatrics* 75:299–303.
- Stryker, W. S., Gunn, R. A., and Francis, D. P. 1986. Outbreak of hepatitis B associated with acupuncture. *Journal of Family Practice* 22:155–158.
- Tietjen, L., Cronin, W., and McIntosh, N. 1992. *Infection prevention for family planning service programs: A problem-solving reference manual*. Durant, OK: Essential Medical Information Systems, Inc.
- Velandia, M., et al. 1995. Transmission of HIV in dialysis centre. *Lancet* 345:1417–1422.
- Wargo, L. G. (ed.). 1997. *Infection control sourcebook 1997*. Atlanta, GA: American Health Consultants.
- Woods, J. A., et al. 1997. Surgical glove lubricants: From toxicity to opportunity. *Journal of Emergency Medicine* 15(2):209–220.
- World Health Organization, Regional Office for the Western Pacific. 1993. *Infection control*, Vol. 3. Manila.

Index

- Active chlorine, 26–27
- Administrative areas,
 cleaning of, 57
- Airborne transmission of
 infections, 2
- Alcohol
 use in handwashing, 6
 use in surgical scrub, 10
 60%–90% ethyl or isopropyl,
 6, 15, 17, 21, 48
- Ammonia, 57
- Ammonium chloride, 57
- Antibiotic resistance, 18
- Antibiotics, 18, 19
- Antiseptics, 14–17
 properties of common
 antiseptics, 16–17
 use in client prep, 14–15
 use in handwashing, 6, 14
 use in surgical scrub, 8–10, 14
- Aseptic technique, 8–19
 components of, 8
 purpose of, 8
- Autoclaves
 maintenance of, 36–37
 pressure-cooker type, 36
 use in steam sterilization,
 34–38
- Autoclaving. *See* Steam
 sterilization
- Benzalkonium chloride, 15, 47
- Betadine, 15, 16, 48. *See also*
 Antiseptics
- Biological indicators, 42
- Bleach. *See* Chlorine bleach
- Bleaching powder. *See* Chlorine
 bleach
- Boiling, 45–47
- Brush, use during surgical
 scrub, 9–11
- Burial of waste, 59, 66–67
- Burning of waste, 59, 65–66
- Caps, 8. *See also* Linens
- Carbolic acid, 48
- Ceilings, cleaning of, 58, 59
- Chemical HLD, 47–50
- Chemical indicators, 42
- Chemical sterilization, 32, 40–42
- Chemical waste, 62–63
- Chlorhexidine gluconate, 15, 16–
 17, 48. *See also* Antiseptics
- Chlorine. *See also* Disinfectants
 about chlorine, 26
 bleach powder, 26–27
 chlorine bleach, 26–27
 liquid bleach, 26–27
 mixed with cleaning
 products, 57
 properties of, 48
 tablets, 26–27
 use in HLD, 47–48
 0.5% chlorine solution, 23,
 26–27, 28, 29, 56, 57, 59,
 60, 67
- Chloroxylonol, 17. *See also*
 Antiseptics
- Cidex, 40, 48
- Cleaning, 25, 29–31, 57
 cleaning solutions, 56–57, 67
 for instrument processing,
 29–30, 32
 of autoclaves, 37
 of client-care areas, 58–59
 of floors and surfaces, 56
 of linens, 31
 of low-risk areas, 57–58
 of MVA instruments, 31
 of reusable needles and
 syringes, 31
 of spills, 59, 60
 of surgical gloves, 31
 of toilets, latrines, and sluice
 rooms, 58
 schedules for, 58, 59
- Client-care areas
 cleaning of, 59
 waste removal for, 64
- Client prep, 8, 14
- Cold sterilization. *See* Chemical
 sterilization
- Contact, infection transmission
 through, 2
- Cytotoxic drugs, disposal of, 63
- Decontamination
 for instrument processing,
 25–29
 of gloves, 28
 of laparoscopes, 29
 of linens, 29
 of MVA instruments, 29
 of reusable needles and
 syringes, 28
 of sharps, 22–23
 of storage containers, 29
- Degrees chlorum, 26
- Detergent, 30, 31, 56, 57, 60
- Dettol, 17, 48. *See also*
 Antiseptics
- Disinfectant cleaning solution,
 57, 58, 59, 60, 67
- Disinfectant fogging, 60
- Disinfectants. *See also* Solutions
 about disinfectants, 47
 composed of 0.5% chlorine,
 26–27, 56, 57, 58, 59, 60,
 67
 used for cleaning, 56, 57, 58,
 59, 60, 67
 used for HLD, 48
- Disposal
 final, 63, 64, 65–68
 of liquid waste, 67
 of medical waste, 61–68
 of needles and other sharps,
 63, 64, 68
- Drum incinerator, 65–66
- Dry dusting, 56
- Dry-heat sterilization, 32, 39–40
- Dump, community, 67
- Electric ovens. *See* Dry-heat
 sterilization
- Ethylene oxide gas, 44
- Exam gloves, 7
- Eyecovers, 8, 30, 31
- Faceshield, 8, 31
- Flaming (holding items in a
 flame), 45
- Footwear, 8
- Formaldehyde, 40, 48, 60. *See*
 also Disinfectants
- Formalin, 60. *See also*
 Disinfectants
- Fumigation, 60
- General waste, 62, 63, 65, 66
- Gloves, 7, 8, 9, 11, 28–29, 50, 56,
 60, 65, 67
 cleaning of, 31
 decontamination of, 25, 28
 disposable (single use), 7, 28,
 43, 50
 exam. *See* Exam gloves
 powder used on, 38
 reuse of, 50
 surgical. *See* Surgical gloves
 three kinds of, 7
 tips for use of, 7
 use during housekeeping, 56
 utility. *See* Utility gloves
- Glutaraldehyde, 40, 41, 44, 47,
 48, 49, 67. *See also*
 Disinfectants
- Gowns, 8. *See also* Linens
- Handrub, alcohol, 6
- Handscrub. *See* Surgical scrub
- Hands-free technique, 21, 24
- Handwashing, 5–6
 appropriate times for, 5
 routine, steps of, 5
 three kinds of, 5
 tips for, 6
 with alcohol, 6
 with antiseptics, 6
 without running water, 6
- Hepatitis
 and infection transmission, 1,
 2, 3, 4
 postexposure prophylaxis for,
 24
- Hibiclens, 16. *See also*
 Antiseptics
- Hibiscrub, 16, 48. *See also*
 Antiseptics
- Hibitane, 16, 48. *See also*
 Antiseptics
- High-level disinfection (HLD),
 32, 44–52
 by boiling, 45–47
 by steaming, 50
 disinfectants used in, 47, 48
 of linens, 52
 of MVA instruments, 52
 of reusable needles and

syringes, 52
using chemicals, 47–50
HIV (human immunodeficiency virus) and infection transmission, 1, 2, 3, 4
postexposure prophylaxis for, 24
HLD. *See* High-level disinfection
Housekeeping, 56–68
cleaning procedures for, 57–59
cleaning solutions used in, 56, 57
general guidelines for, 56
ineffective practices, 60–61
Human immunodeficiency virus. *See* HIV
Hydrogen peroxide, 15, 48
Hypodermic needles and syringes, 20–22, 23, 24, 28, 31, 43–44, 52, 63, 64, 68.
See also Sharps
burning of, 68
cleaning of, 31
decontamination of, 28
disposal of, 63, 64, 68
handling of, 20–21, 64
HLD of, 52
recapping of, 21–22, 24, 68
sorting of, 63–64
sterilization of, 43–44
Incineration, 65, 68
Indicators for sterilization, 42
Infection prevention, importance of, 1–4
Infection transmission
in health care settings, 1
modes of, 2
prevention of, 4
risks of, 3
Infections
causes of, 2
increase of, 1
in health care settings, 1
transmission of. *See* Infection transmission
Injections, 20
Injury, management of, 23–24
Instrument processing, 25–55
organizing an area for, 53–55
steps of, 25
Interim storage of waste, 64–65
Iodine, 15, 16, 17. *See also*
Antiseptics
tincture of iodine, 17
Iodophors, 15, 16–17, 48. *See also* Antiseptics
IV fluids, 20
Laboratories, cleaning of, 58
Laparoscopes
decontamination of, 29
Latex allergies, 38
Latrines
cleaning of, 57–58

Linens
cleaning of, 31
decontamination of, 29
HLD of, 52
sterilization of, 44
Liquid bleach. *See* Chlorine
Liquids, sterilization of, 43
Low-level disinfectants, 47, 48
Low-risk areas, cleaning of, 57
Lysol, 47, 48, 57
Maintenance
of autoclaves, 36–37
of dry-heat ovens, 40
Management
of injuries, 23
of waste, 63–68
Manual vacuum aspiration. *See* MVA instruments
Masks, 8, 30, 31. *See also* Linens
Mayo stands, cleaning of, 59
Mechanical indicators, 42
Medical waste, 59, 62, 63, 64, 65–68
final disposal of, 65–68
handling of, 64
interim storage of, liquid, 67
solid, 65–67
sorting of, 63
Mercury, 15
Microorganisms, 2, 6, 8, 9, 10, 14, 15, 20, 26, 29, 30, 31, 32, 44, 45, 47, 53, 57, 60
modes of transmission of, 2
Monitoring of sterilization, 42
Mops, 56, 57, 58, 59, 60
Multidose vials, 20–21
MVA instruments
cleaning of, 31
decontamination of, 29
HLD of, 52
steaming of, 51
sterilization of, 44
Needles. *See* Hypodermic needles and syringes
Normal flora, 2
One-hand technique, 21–22
Open burning, 65
Operating table, cleaning of, 59
Operating theater
cleaning of, 57, 59
sterile field in, 18
waste removal for, 64
Para-chloro-*meta*-xylenol, 17.
See also Antiseptics
Paraformaldehyde, 60
Pathogens, 2, 24
PCMX. *See Para*-chloro-*meta*-xylenol
Phenol, 47, 48, 57
Phosphoric acid, 57
Postexposure prophylaxis, 24

Povidone iodine. *See* Iodophors
Powdered bleach. *See* Chlorine
Powder; use on gloves, 38
Procedure room
cleaning of, 58, 59
waste removal for, 64
Processing. *See* Instrument processing
Processing rooms
cleaning of, 58, 59
organization of, 53–55
Prophylactic antibiotics, 18, 19
Prophylaxis, postexposure, 24
Quaternary ammonium compounds, 15, 47, 57
Radioactive waste, disposal of, 63
Recapping. *See* Hypodermic needles and syringes, recapping of
Risk of infection, 3–4
Savlon, 16, 48. *See also* Antiseptics
Scavenging of waste, 3, 62, 64, 67
Schedules for cleaning, 58, 59
Scrub. *See* Surgical scrub
Scrubbing
during housekeeping, 56, 60, 61
of hands, 9–10
of instruments. *See* Cleaning
Separation of waste. *See* Sorting of waste
Shampooing carpeted areas, 57
Sharps, 20–24
burial of, 68
burning of, 22, 68
decontamination of, 22–23
disposal containers for, 20, 21, 22, 59, 63, 64, 68
disposal of, 20, 21, 22, 59, 64, 68
injury from, 20, 24, 61–62, 68
safe handling of, 21–22
sorting of, 63–64
Sharps-disposal containers, 20, 21, 22, 59, 63, 64, 68
Shaving of the surgical site, 14, 15
Sinks
cleaning of, 58
in processing, 54–55
Sluice rooms
cleaning of, 57–58
waste removal for, 64
Soap and water
used for handwashing, 5
used for surgical scrub, 10
Solutions
alcohol handrub solution, 6
and multidose vials, 20
antiseptic, 10, 14–15

- contamination of, 14–15
- disinfectant, 56, 57, 58, 59, 60
- in multidose vials, 20
- of 0.5% chlorine, 23, 26–27, 28, 29, 56, 57, 59, 60, 67
- proper handling of, 15
- used for cleaning, 56–57, 67
- used for sterilization, 40, 41
- Sorting of waste, 63–64
- Spills, cleaning of, 59, 60
- Sporicidin, 48
- Standard precautions, 4
- Steam
 - method of HLD, 50–52
 - method of sterilization. *See* Steam sterilization.
- Steam sterilization (autoclaving), 34–38
 - of linens, 44
 - of liquids, 43
 - of surgical gloves, 38
- Steps
 - of chemical HLD, 49
 - of chemical sterilization, 41
 - of cleaning instruments, 30
 - of decontaminating needles and syringes, 23
 - of decontamination, 28
 - of dry-heat sterilization, 39–40
 - of HLD by boiling, 46
 - of HLD by steaming, 51
 - of instrument processing, 25
 - of putting on surgical gloves, 11–12
 - of removing contaminated surgical gloves, 13
 - of routine handwashing, 5
 - of steam sterilization, 34–35
 - of surgical scrub, 9–10
 - of the one-hand technique, 22
 - of wrapping gloves, 38
 - of wrapping items for sterilization, 33
- Sterile field, establishing and maintaining a, 8, 18
- Sterile water, 41, 43
- Sterilization, 25, 32–44, 45
 - effectiveness of, 32, 42
 - of liquids, 43
 - using chemicals, 40–41
 - using dry heat, 39–40
 - using steam (autoclaving), 34–38
 - wrapping gloves for, 38
 - wrapping items for, 32–33
- Storage containers
 - decontamination of, 29
 - for waste. *See* Waste containers
- Storage, 35, 40, 41, 46, 49, 52–53, 64–65
 - after boiling, 46
 - after chemical HLD, 49
 - after chemical sterilization, 41
 - after dry-heat sterilization, 40
 - after HLD by steaming, 51
 - after instrument processing, 52–53
 - after steam sterilization, 35
 - of waste, 64–65
 - of wrapped items, 53
- Surfaces, cleaning of, 58, 59
- Surgical attire, 8. *See also* Linens
- Surgical drapes, 18. *See also* Linens
- Surgical gloves, 7, 8, 11–13, 31, 50–52, 38, 39, 43
 - cleaning of, 31
 - decontamination of, 28
 - powdering of, 38
 - putting on, 11–12
 - processing for reuse, 43
 - removing, 12–13
 - steaming of, 50–51
 - sterilization of, 38, 43
 - wrapping of, 38
- Surgical scrub, 9–10
 - alternative methods of, 10
 - steps of, 9
- Surgical technique, 18
- Sweeping, 56
- Syringes. *See* Hypodermic needles and syringes
- Techniques
 - hands-free, 21
 - one-hand, 22
 - safe surgical, 8, 18
- Tincture of iodine. *See* Iodine
- Toilets
 - cleaning of, 57–58
- Transmission of infections. *See* Infection transmission
- Transporting of waste, 65, 67
- Ultraviolet (UV) light, 60, 61
- Utility gloves, 7, 23, 24, 28, 29, 30, 56, 65, 67
- Vaccination following exposure to infectious materials, 23–24
- Vacuuming, 57
- Vector, infection transmission through, 2
- Vehicle, infection transmission through, 2
- Waiting rooms, cleaning of, 57
- Walls, cleaning of, 58, 59
- Washing
 - of hands. *See* Handwashing
 - of instruments. *See* Cleaning of floors and surfaces, 56, 59
- Waste
 - burial of, 66–67
 - burning of, 65–66
 - disposal of, 61–68
 - final disposal of, 65–68
 - handling of, 64
 - management plan, 63
 - radioactive, 62–63
 - sorting of, 63–64
 - storage of, 64–65
 - three kinds of, 62–63
 - transporting of, 64, 67
- Waste containers
 - cleaning of, 58, 59
 - correct use of, 63, 65
 - emptying of, 58, 59, 64
 - for sharps. *See* Sharps-disposal containers
- Waste disposal, 61–68
- Water, sterilization of, 43
- Waterproof aprons, 8, 31
- Wrapping items for sterilization, 32–33, 38
- Zephiran, 15