

Guidelines for the Storage of Essential Medicines and Other Health Commodities



DELIVER



in collaboration with the
World Health Organization

unicef 



DELIVER

DELIVER, a five-year worldwide technical assistance support contract, is funded by the Commodities Security and Logistics Division (CSL) of the Office of Population and Reproductive Health of the Bureau for Global Health (GH) of the U.S. Agency for International Development (USAID).

Implemented by John Snow, Inc. (JSI), (contract no. HRN-C-00-00-00010-00), and subcontractors (Manoff Group; Program for Appropriate Technology in Health [PATH]; Social Sectors Development Strategies, Inc.; Synaxis, Inc.; Boston University Center for International Health; Crown Agents Consultancy, Inc.; Harvard University Health Systems Group; and Social Sectors Development Strategies), DELIVER strengthens the supply chains of health and family planning programs in developing countries to ensure the availability of critical health products for customers. DELIVER also provides technical support to USAID's central contraceptive procurement and management, and analysis of USAID's central commodity management information system (NEWVERN).

This document does not necessarily represent the views or opinions of USAID or the World Health Organization. It may be reproduced if credit is given to John Snow, Inc./DELIVER.

Recommended Citation

John Snow, Inc./DELIVER in collaboration with the World Health Organization. *Guidelines for the Storage of Essential Medicines and Other Health Commodities*. 2003. Arlington, Va.: John Snow, Inc./DELIVER, for the U.S. Agency for International Development.

Abstract

Maintaining proper storage conditions for health commodities is vital to ensuring their quality. Product expiration dates are based on ideal storage conditions and protecting product quality until their expiration date is important for serving customers and conserving resources.

Guidelines for the Storage of Essential Medicines and Other Health Commodities is a practical reference for those managing or involved in setting up a storeroom or warehouse. The guide contains written directions and clear illustrations on receiving and arranging commodities; special storage conditions; tracking commodities; maintaining the quality of the products; constructing and designing a medical store; waste management; and resources. It was written to meet the needs of district-level facilities; however, the guidelines and information it contains apply to any storage facility, of any size, in any type of environment.

ACKNOWLEDGMENTS

Sincere thanks go to Marthe Everard, Technical Officer, WHO/EDM, for her thorough technical reviews and very helpful suggestions; to Joe Azar for his wonderful illustrations; to Richard Carr, Scientist, WHO/SDE, for his help with the section on waste management; and to Dean Sherrick, Lieutenant, Fairfax County Fire Department, for his technical review and suggestions on fire safety.

Special recognition goes to UNICEF for their review and approval of this guide.

Special thanks also go to all of the DELIVER staff who wrote sections and reviewed this document, including Claudia Allers, Dana Aronovich, Yasmin Chandani, Bernard Fabre, Barbara Felling, Mohammad Anwar Hossain, Shyam Lama, Paula Nersesian, Timothy O’Hearn, Rich Owens, and Greg Roche; and to Gus Osorio and Pat Shawkey of the DELIVER communications team.

Laurie Lyons, Editor
December 2003

TABLE OF CONTENTS

Routine Warehouse or Storeroom Management Tasks.. 8

1. Receiving and Arranging Commodities	11
Receiving Health Commodities.....	13
Arranging Commodities	15
Stock Rotation	18
Orderly Arrangement of Essential Medicines	20
Special Storage Conditions.....	22
Examples of Access-Controlled Storage.....	24
Flammables	25
Corrosives	27
2. Keeping Track of Products in Your Storeroom.....	29
Standard List of Stock Items	31
Stock Records	32
Physical Inventory.....	35
3. Maintaining the Quality of Your Products	39
Monitoring Product Quality	41
Preventing Damage and Contamination	44
Protecting Against Fire.....	47
Protecting Against Pests.....	52
Controlling Temperature	57
Protecting Against Theft.....	65

4. Setting Up Your Medical Store	69
Constructing a Medical Store	71
Designing a Medical Store	73
Materials Handling Equipment and Storage Media	78
5. Waste Management	81
Considering Waste Management	83
Types of Waste	84
Disposal Methods	86
6. Bibliography	93
7. Annexes	97
Annex 1: Resources.....	99
Annex 2: Suggested Reading	102
Annex 3: Sample Forms	107
Annex 4: Medicine Names	110
Annex 5: Conversion Factors	111

ROUTINE WAREHOUSE OR STOREROOM MANAGEMENT TASKS

Note: Specific tasks may differ based on locally established guidelines, procedures, and regulations, or the level in the system (e.g., district, region, or central).

Daily/Weekly

- Monitor storage conditions.
- Clean receiving, storage, packing, and shipping areas.
- Sweep or scrub floors.
- Remove garbage.
- Clean bins, shelves, and cupboards, if needed.
- Ensure that aisles are clear.
- Ensure adequate ventilation and cooling.
- Ensure that products are protected from direct sunlight.
- Monitor store security and safety.
- Check the store roof for leaks, especially during the rainy season and during or after a storm.
- Monitor product quality (visually inspect commodities and check expiration dates).
- Ensure that products are stacked correctly (are the lower cartons being crushed?).

Daily/Weekly

- Update stock records and maintain files.
- If cycle counting, conduct physical inventory and update stockkeeping records.
- Monitor stock levels, stock quantities, and safety stocks.
- Submit emergency order (as needed, using local guidelines).
- Update back-up file for computerized inventory control records.
- Update bin cards.
- Separate expired stocks and move to secure area.

Monthly

- Conduct physical inventory or cycle count, and update stockkeeping records.
- Run generator to ensure the system is working correctly; check the level of fuel and add fuel, if needed.
- Check for signs of rodents, insects, or roof leaks.
- Inspect the storage structure for damage, including the walls, floors, roof, windows, and doors.

Every 3 months (quarterly)

- Conduct physical inventory or cycle count, and update stockkeeping records.
- Use established procedures to dispose of expired or damaged products.

- Visually inspect fire extinguishers to ensure that pressures are maintained and extinguishers are ready for use.

Tasks according to reorder interval and reporting schedule (usually monthly or quarterly)

- Assess stock situation.
- Complete and submit requisition form (indent or “pull” systems).
- Determine issue quantity and issue products (“push” systems).
- Receive products.
- Store products using correct procedures; rearrange commodities to facilitate the first-to-expire, first-out (FEFO) policy. (See section on receiving and arranging products.)
- Complete required reporting and documentation.

Every 6 months

- Conduct fire drills and review fire safety procedures.
- Inspect trees near the medical store and cut down or trim any trees with weak branches.

Every 12 months

- Service fire extinguishers and smoke detectors.
- Conduct complete physical inventory and update stockkeeping records.
- Reassess maximum/minimum stock levels, and adjust if needed.

1. Receiving and Arranging Commodities

1. Receiving and Arranging Commodities

RECEIVING HEALTH COMMODITIES

When you receive health commodities—

- 1 Ensure there is sufficient storage space.
- 2 Prepare and clean the areas used for receiving and storing the products.
- 3 Inspect packages for damaged or expired products.



If	Then
Products are damaged or expired	<ol style="list-style-type: none">1. Separate the damaged or expired stock from the usable stock.2. If damage or expiry is discovered while the delivery truck is still at your site, refuse to accept the products and note the problem(s) on the delivery note.3. If damage or expiry is discovered after the delivery truck has departed, follow your facility's procedures for handling damaged or expired stock.

Products are not damaged or expired	<ol style="list-style-type: none">1. Count the number of units for each product received and compare to issue voucher.2. Record the date and quantity received on stock card and bin card (if applicable).3. Ensure the expiry date is visibly marked on every package or unit.4. Arrange products in the storage area to facilitate the first-to-expire, first-out (FEFO) procedure. (See section on stock rotation.)
--	---

ARRANGING COMMODITIES

1

Arrange the storeroom and shelves as follows:

If using pallets, stack cartons on pallets—

- at least 10 cm (4 inches) off the floor
- at least 30 cm (1 foot) away from the walls and other stacks
- no more than 2.5 m (8 feet) high (general rule).

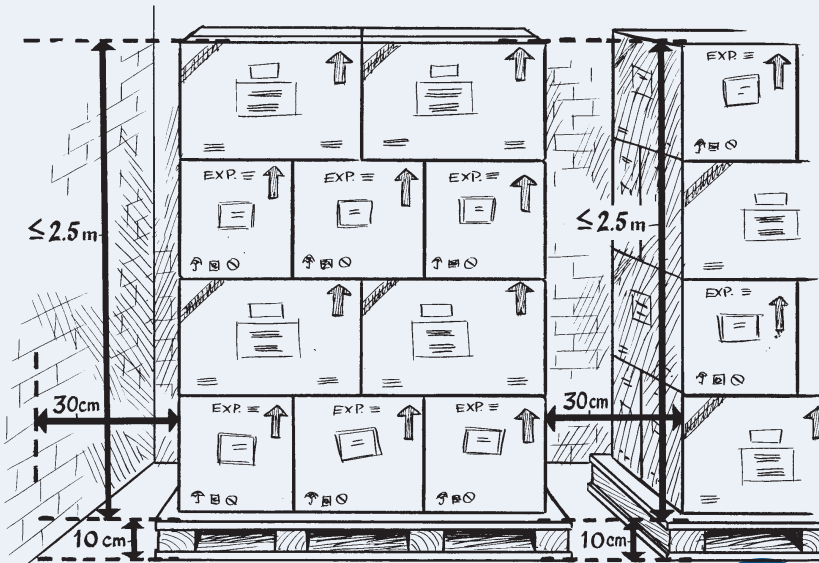

For all storage:

- Follow the manufacturer or shipper's directions when stacking, and follow labels for storage conditions.
- Place liquid products on the lower shelves or on bottom of stacks.
- Store products that require cold storage in appropriate temperature controlled zones.
- Store high security/high value products in appropriate security zones.
- Separate damaged or expired products from the usable stock without delay, and dispose of using established disposal procedures. (See section on Waste Management.)
- Always store all commodities in a manner that facilitates FEFO policy for stock management.

- Arrange cartons so arrows point up and identification labels, expiry dates, and manufacturing dates are visible. If this is not possible, write the product name and expiry date clearly on the visible side.



STOCK ROTATION

When issuing products, it is important to follow the FEFO policy.



Following FEFO minimizes wastage from product expiry.

- Always issue products that will expire first, ensuring they are not too close to or past their expiration date. The shelf life remaining must be sufficient for the product to be used before the expiry date.
- To facilitate FEFO, place products that will expire first in front of products with a later expiry date.
- Write expiry dates on stock cards, so stocks can be sent to facilities at least 6 months before they expire.

Remember, the order in which you received products is not necessarily the order in which they will expire. Products you received most recently may expire sooner than the products you received earlier. So, it is extremely important to always check the expiration dates and to make sure the dates are visible while the products are in storage.

ORDERLY ARRANGEMENT OF ESSENTIAL MEDICINES

Medical stores must have a system for classifying or organizing medicines, and must ensure that all employees know the system being used.

Some common systems for arranging medicines include—

Alphabetical order by generic name: Often seen in both large and small facilities. When using this system, the labeling must be changed when the Essential Medicines List is revised or updated.

Therapeutic or pharmacologic category: Most useful in small storerooms or dispensaries where the storekeeper is very knowledgeable about pharmacology.

Dosage form: Medicines come in different forms, such as tablets, syrups, injectables, and external use products such as ointments and creams. In this system, medicines are categorized according to their dosage form. Within the area for each form, a fixed, fluid, or semi-fluid system is used to store items. Any of the other methods of categorizing can be used to organize the items more precisely.

System level: Items for different levels of the health care system are kept together. This works well in stores at a higher level when storage of kits is required.

Frequency of use: Frequently used products that move quickly or often through the store should be placed in the front of the room or closest to the staging area. This system should be used in combination with another system.

Random bin: Identifies a specific storage space or cell with a code that corresponds to its aisle, shelf, and position on the shelf. This system requires computer automation.

Commodity coding: Each item has its own article and location code. This system has the greatest flexibility, but it is also the most abstract. Stores staff do not need any technical knowledge of the products to manage this system because the codes contain the information needed for storing products properly, such as temperature requirements, level of security, and flammability. This system works well in computerized inventory control systems.

SPECIAL STORAGE CONDITIONS

Some products need storage in an access-controlled environment.

It is important to identify products that are at risk of theft or abuse or have the potential for addiction, and to provide increased security for those items. This includes products that are in high demand or have the potential for resale (black market value).

Usually, National Essential Medicines Lists (NEML) include several narcotics and psychotropic medicines; one or two will be on facility lists. Typical examples are—

Narcotics: morphine, opium preparations, pethidine, diamorphine, papaveretum, hydrocodone and oxycodone, dipipanone, and tramadol.

Other opioid and strong analgesics: pentazocine, codeine, dihydrocodeine, dextropropoxyphene, dextromoramide, and buprenorphine.

Psychotropic drugs: usually the group of drugs called “benzodiazepines,” the more common being diazepam, temazepam, nitrazepam, flunitrazepam, and oxazepam. Clonazepam, used to treat epilepsy, may be found under a

different class, and is not always under the same control. Strong tranquilizing medicines, such as chlorpromazine, may also be found under this heading.

Some of the medicines mentioned earlier are controlled substances, which are medicines handled under international control. These medicines need greater attention. There are specific procedures in place for the procurement, reception, storage, dispensing, and administration of controlled substances. Special ordering forms should be used.

Note: Other medicines, including antiretrovirals used to treat HIV/AIDS, may need storage in a controlled facility, because they are scarce, expensive, and in high demand.

Organizations donating medicines may require that those medicines be stored in a controlled environment. These may be products donated for a specific condition that can also be used for other conditions. Examples include medicines used to treat opportunistic infections for HIV/AIDS and medicines used to treat sexually transmitted infections that might also be on the NEML and used for other conditions; or HIV test kits that may be donated for use in specific programs, such as preventing mother-to-child transmission, but can be used for other purposes, such as ensuring blood safety.

EXAMPLES OF ACCESS-CONTROLLED STORAGE

If you have products that need increased security, you must establish access-controlled storage. This will probably include storing the products in—

- a separate locked room, cabinet, or safe, or
- a locked wire cage within the storage facility.

Ideally a warning light or bell will be activated if the products are accessed improperly.

Entry to the location of the access-controlled products must be limited to the most senior storekeeper or pharmacist and one other staff member.

Limit the number of keys made for the controlled location and keep a list of people who have keys.

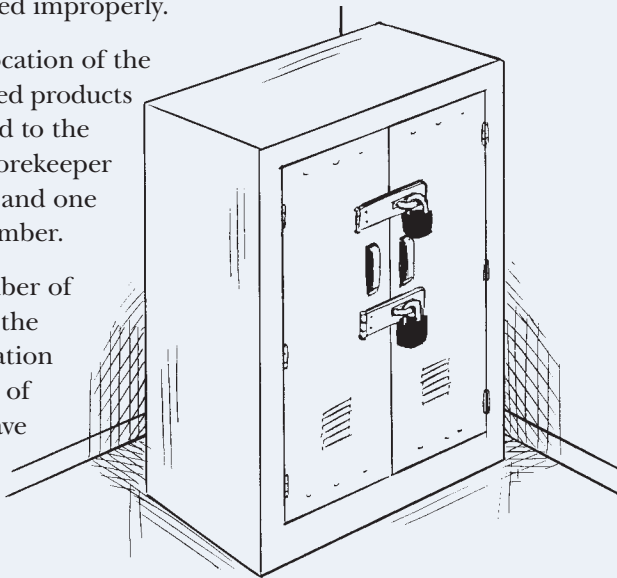

FLAMMABLES

Some flammable liquids commonly found in health facilities include acetone, anesthetic ether, alcohols (before dilution), and kerosene.

Store large supplies of flammables in a separate location away from the main storeroom, preferably outside the main storeroom but on the premises and not less than 20 m away from the other buildings. Fire fighting equipment should be easily available. Large supplies of flammables should never be stored in the same areas as medicines.

A small stock of flammables may be kept in a steel cabinet in a well-ventilated area, away from open flames and electrical appliances. Mark the cabinets to indicate that they contain highly flammable liquids, and display the international hazard symbol. In addition, the shelves of the cabinet should be designed to contain and isolate spillage. Always store flammables in their original container.

Flammable liquids each have a flash point, which is the minimum temperature at which the liquid gives off vapor in sufficient concentration to form an ignitable mixture with air near the surface of the liquid. The flash point indicates the susceptibility to ignition.

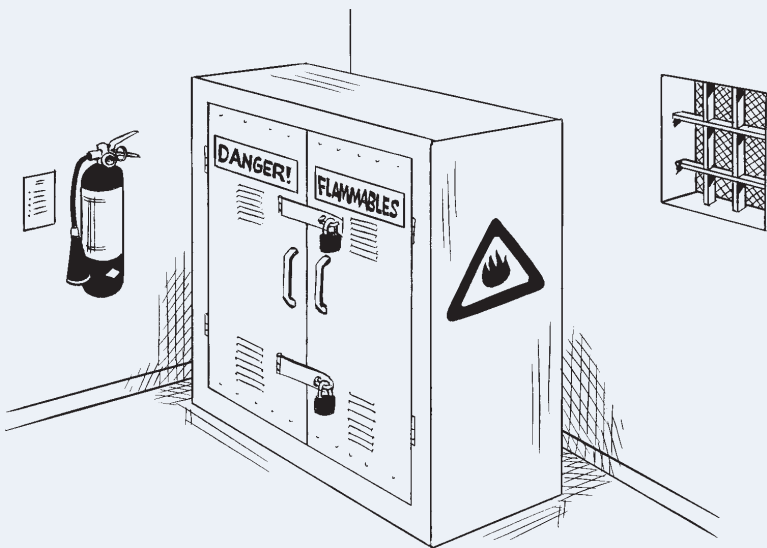

- Acetone and anesthetic ether have a flash point of -18°C .
- Undiluted alcohols have a flash point of 18° to 23°C .
- The flash point for kerosene is 23° to 61°C .

It is not necessary to store flammables below their flash point, but it is very important to store them in the coolest location possible and never in direct sunlight. It is important to control the evaporation rate and avoid the build-up of pressure.

CORROSIVES

Corrosive or oxidant substances commonly found in hospitals or other high-level health facilities include trichloroacetic acid, glacial acetic acid, concentrated ammonia solutions, silver nitrate, sodium nitrate, and sodium hydroxide pellets.

Always store corrosive substances away from flammables, ideally in a separate steel cabinet to prevent leakage. Use appropriate industrial-type protective gloves and eye-glasses when handling these items.

2. Keeping Track of Products in Your Storeroom

2. Keeping Track of Products in Your Storeroom

STANDARD LIST OF STOCK ITEMS

Each medical store should maintain a standard list of stock items that includes all products they handle, with their specifications, including form, strength, and quantity per package. The list should be regularly updated and distributed to sub-stores and units.

Do not order products that are not on the standard list unless you have special permission. You should not accept deliveries of products not on the list unless special circumstances have been identified.

Inventory records should be maintained for all products on the list.

STOCK RECORDS

The minimal information that should be collected on stock records for medicines and other health products includes—

- product name/description (including the form [e.g., capsule, tablet, liquid suspension, etc.] and strength)
- stock on hand/beginning stock balance
- receipts
- issues
- losses/adjustments
- closing/ending balance
- transaction reference (e.g., issue voucher number or name of supplier or recipient).

Depending on the system, stock records might also include additional product information such as—

- special storage conditions (e.g., 2°–8°C)
- unit prices
- lot numbers/bin locations
- item codes
- expiry dates.

A logistics information system must have three different types of records: stockkeeping records, transaction records, and consumptions records. See annex 3 for sample forms of each. Clinic-level facilities may use other forms in addition to these.

INVENTORY CONTROL CARD

Commodity Number		Description			Location	
Unit		Maximum Stock	Minimum Stock			
Date	Transaction Reference	Quantity Received	Quantity Issued	Losses/Adjustments	Quantity On Hand	Quantity On Order

Stock records might also include certain calculated data items. These are determined by mathematical formulas, that depend on system design parameters (e.g., how often orders are placed). Calculated data items include—

- consumption data, such as average monthly consumption (AMC)
- lead times for ordering/requisition
- maximum and minimum stock levels
- emergency order point.

A storage and distribution system may not necessarily use all these forms, but it will need forms to record stockkeeping data and product transactions. Standard forms used for inventory control include—

- stock cards
- bin cards
- requisition/issue vouchers
- receiving forms (packing slip/freight bill)
- delivery/issue vouchers
- expired stock disposal forms
- physical inventory forms
- list of approved medicines and prices.

PHYSICAL INVENTORY

A physical inventory is the process of counting by hand the number of each type of product in your store at any given time. A physical inventory helps ensure that the stock on hand balances recorded on stockkeeping records match the quantities of products actually in the store. When conducting a physical inventory, count each product individually by generic name, dosage form, and strength.

There are two kinds of physical inventory:

Complete physical inventory: All products are counted at the same time. A complete inventory should be taken at least once a year. More frequent inventory (quarterly or monthly) is recommended. For large warehouses, this may require closing the storage facility for a day or longer.

Cyclic or random physical inventory: Selected products are counted and checked against the stockkeeping records on a rotating or regular basis throughout the year. This process is also called cycle counting.

A complete physical inventory is easier to conduct regularly at facilities that manage smaller quantities of products. Cyclic or random physical inventory is usually appropriate at facilities that manage larger quantities of products.

Cyclic physical inventory can be organized in many ways—

Dosage form: Count tablets in January, capsules in February, liquids in March, etc.

Location in the storeroom: Count shelves 1–4 in January, 5–8 in February, etc.

Time availability: Count a few items each day whenever staff have time.

Stock on hand: On a periodic basis, count each item for which stock on hand is at or below the minimum inventory level. This method may be faster, since there are smaller quantities to count.

If cyclic physical inventory is used, count each product at least once during the year. Count fast-moving items and full supply products more frequently.

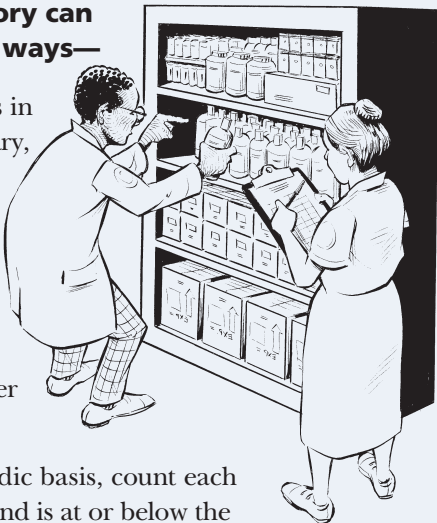

Steps in conducting a physical inventory:

1 Plan.

- For a complete physical inventory, schedule the day(s) and time.
- For a cyclic or random physical inventory, identify which products will be counted and the corresponding time period for those products.

2 Assign staff.

3 Organize the storeroom.

- Arrange products according to FEFO.
- Make sure open cartons and boxes are visible.
- Separate damaged or expired products.

4 Count the usable products.

- Count products according to the units by which they are issued (e.g., tablet or piece) not by the carton or box.
- Estimate quantities in open containers for products packaged in bulk. If a bottle of 1,000 capsules is $\frac{2}{3}$ full, estimate 650 or 700 capsules. If you have a one liter bottle of syrup that is $\frac{1}{2}$ full, estimate 0.5 liters.

- 5 Update the stockkeeping records.**
 - Write the date of the physical inventory and the words “Physical Inventory.”
 - Using a different color ink, write the quantity of the product that you counted during stocktaking.

- 6 Take action based on the results of the physical inventory.**
 - If the results of the physical inventory differ from the balance on the stock/bin card, update the balance by adding or subtracting the excess or missing quantities.
 - Dispose of damaged or expired products found during the physical inventory.
 - For either of the above, identify, document, and correct the cause of the problem.

- 7 Discuss the findings of the inventory with the facility staff.**
 - Congratulate the staff, if appropriate.
 - Take corrective actions, if required.

3. Maintaining the Quality of Your Products

3. Maintaining the Quality of Your Products

MONITORING PRODUCT QUALITY

Indicators of quality problems:

Products of different types show damage in different ways. Some indicators you can use to detect damage are—

All products

- broken or ripped packaging (vials, bottles, boxes, etc.)
- missing, incomplete, or unreadable label(s)



Liquids

- discoloration
- cloudiness
- sediment
- broken seal on bottle
- cracks in ampoule, bottle, or vial
- dampness or moisture in the packaging



Light-sensitive products (such as x-ray film)

- torn or ripped packaging

Latex products

- dry
- brittle
- cracked

Lubricated latex products

- sticky packaging
- discolored product or lubricant
- stained packaging
- leakage of the lubricant (moist or damp packaging)

Pills (tablets)

- discoloration
- crumbled pills
- missing pills (from blister pack)
- stickiness (especially coated tablets)
- unusual smell

Injectables

- liquid does not return to suspension after shaking

Sterile products (including IUDs)

- torn or ripped packaging
- missing parts
- broken or bent parts
- moisture inside the packaging
- stained packaging

Capsules

- discoloration
- stickiness
- crushed capsules

Tubes

- sticky tube(s)
- leaking contents
- perforations or holes in the tube

Foil packs

- perforation(s) in packaging

Chemical reagents

- discoloration
-

Damaged products should never be issued to facilities or dispensed to clients. If you are not sure if a product is damaged, check with someone who knows. Do not issue or dispense products that you suspect are damaged.

Report any defects and send the defective products back to the facility that issued them to you.

If an inspector visits your facility, report any problems to him or her.

See section 5 on waste management for additional information.

PREVENTING DAMAGING AND CONTAMINATION

Physical damage

Avoid crushing products stored in bulk. Products should be stacked no more than 2.5 m (8 feet) high, as a general rule. Heavier or fragile items (such as those packaged in glass) should be placed in smaller stacks. Bind sharp edges or corners in the store with tape. Most important, ensure that nothing in the store can fall and injure members of the staff.



Dirt

Write and post the schedule and instructions for cleaning the storeroom in multiple locations around the facility.

Sweep and mop or scrub the floors of the storeroom regularly. Wipe down the shelves and products to remove dust and dirt. Dispose of garbage and other waste often, in a manner that avoids attracting pests. Store garbage in covered receptacles.

Infrastructure: Ensure the storeroom has easy access to a water outlet for cleaning. If no running water is available, set up a system using, for example, several 55 gallon drums on an elevated platform connected to pipes running into the store. Refill the drums regularly. When rehabilitating an existing storage facility or constructing a new structure, install water outlets in several locations inside the structure so water is easily available from any location in the storeroom.

Cleaning materials: Keep a budget for buying cleaning materials. Use industrial detergents when possible, particularly for larger facilities, although imported detergents can be expensive. Try to use

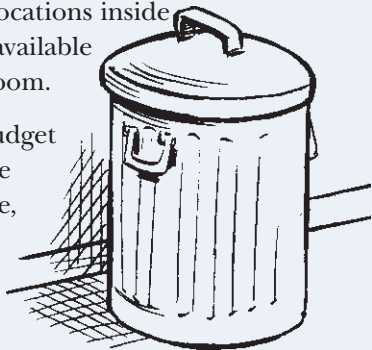

locally available detergents, particularly for smaller or more remote facilities. Clean with chlorine bleach regularly (once a month, for example).

Outside the facility: Burn garden rubbish and cardboard cartons, etc. , when garbage collection is not available. Use the necessary precautions to keep the fire under control, and do not burn materials close to the building. Make sure the wind is not blowing toward the building.

PROTECTING AGAINST FIRE

To prevent damage to products from fire—

- Make standard fire extinguishers available in every storage facility according to national regulations.
- Visually inspect fire extinguishers every 2–3 months to ensure that pressures are maintained and the extinguisher is ready for use.
- Service fire extinguishers at least every 12 months.
- Place smoke detectors throughout the storage facility and check them every 2–3 months to ensure that they are working properly.



- Strictly prohibit smoking in the store.
- Conduct fire drills for personnel every 6 months.
- Clearly mark emergency exits and check regularly to be sure they are not blocked or inaccessible.
- Display fire precaution signs in appropriate places in the storage facility (especially locations where flammables are stored).
- Use sand to extinguish fires where there are no fire extinguishers. Place buckets of sand near the door.



Four main types of fire extinguishers:

Dry chemical extinguishers contain an extinguishing agent such as potassium bicarbonate (similar to baking soda), and use a compressed gas as a propellant. They are effective for multiple types of fire including combustible solids like wood or paper, combustible liquids like gasoline or grease, and electrical fires.

Water extinguishers contain water and compressed gas and should only be used on ordinary combustibles, such as paper and wood. Never use water on fires caused by liquids (such as gasoline or kerosene) or electrical fires.

Carbon dioxide (CO₂) extinguishers are most effective on fires caused by liquids (such as gasoline or kerosene) and electrical fires, but not on fires caused by combustibles like paper, cardboard, or lumber. The gas disperses quickly and does not leave any harmful residue.

Halon extinguishers are often used in areas with computer equipment or other machinery because they leave no residue. They can be used on common combustibles, flammable liquids, and electrical fires. However, halon is dangerous to inhale and harmful to the environment. They are most effective in confined spaces, but remember that the area will need to be ventilated before it can be reoccupied.

Be sure medical store staff are trained in how to use fire extinguishers:

P.A.S.S. is a simple method used to teach fire extinguisher use:



Pull the pin at the top of the extinguisher.



Aim the nozzle toward the base of the fire.



Squeeze the handle to discharge the extinguisher (stand approximately 2.5 m [8 ft] away).



Sweep the nozzle back and forth at the base of the fire.

The P.A.S.S method is accepted for dry chemical and CO₂ extinguishers; however, other methods are needed when using water and other extinguishers and with special fires, such as flammable liquids. Additionally, the P.A.S.S. method may not be appropriate for all dry chemical and CO₂ extinguishers. Be sure to carefully read the instructions for the extinguishers in your facility.

PROTECTING AGAINST PESTS

Prevention inside the storage facility

- Design or modify the storeroom to facilitate cleaning and prevent moisture.
- Maintain a clean environment to prevent conditions that favor pests. For example, store garbage in covered garbage bins. Regularly clean floors and shelves.
- Do not store or leave food in the storage facility.
- Keep the interior of the building as dry as possible.
- Paint or varnish wood, as needed.
- Use pallets and shelving.
- Prevent pests from entering the facility.
- Inspect the storage facility regularly for evidence of pests.

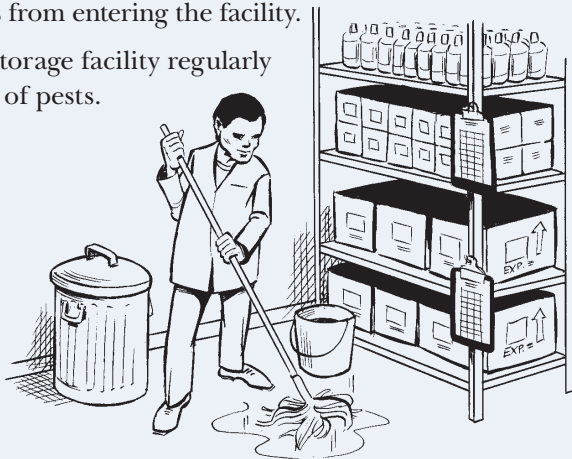

- Packaging and shipping cartons can be treated to prevent pest infestation. For example, cartons can be shrink-wrapped or non-toxic desiccating (dehydrating) agents can be added.

Prevention outside the storage facility

- Regularly inspect and clean the outside premises of the storage facility, especially areas where garbage is stored. Check for any rodent burrows, and be sure that garbage and other waste is stored in covered containers.
- Check for still or stagnant pools of water in and around the premises, and be sure that there are no buckets, old tires, or other items holding water.
- Treat wood frame facilities with water sealant, as needed.
- Use mercury vapor lighting where possible, and locate lighting away from the building to minimize the attraction of pests.

Strategies for specific pests

Rodents: Rodent problems are best solved by prohibiting rodent entry and maintaining a dry, clean facility. Other alternatives include keeping cats; traditional, spring-loaded snap traps baited with food; glue boards, which are disposable plastic or wood trays partially filled with nontoxic, adhesive glue; bait boxes, which are shoe-sized boxes with lids and holes on each end containing toxic rodenticide packets; electronic ultrasonic devices, which emit high-frequency sounds, causing rodents to avoid the area; or rat poison.

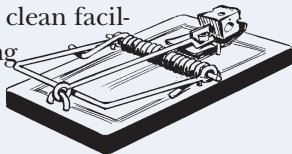

Birds or bats: If the facility has space between the ceiling and the roof, cover all the openings with fine wire mesh to prevent birds or bats from entering the storeroom.

Flying pests: The best prevention is to keep all doors and windows of the storage facility closed or screened off from the outside. Make sure there are no holes in the walls, floor,

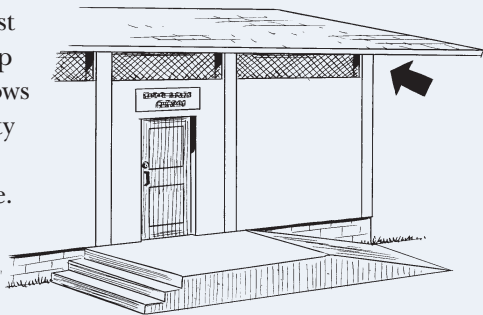

or ceiling. Insect electrocuting light traps (“bug zappers,” hanging electric grids that attract flying insects via a bright fluorescent or ultraviolet light) may be appropriate in some situations. However, they should be placed away from supplies, since ultraviolet light damages a number of products (especially latex products, such as male condoms).

Reptiles: Most snake species are innocuous and can be managed with noisemakers and by keeping the outside of the facility clear of bushes. If snakes are an especially difficult problem in your area, you can construct a snake-proof fence around the perimeter of the facility. The fence should be made with heavy, galvanized screen with 6 mm wire mesh. The fence should be 90 cm tall with the lower end buried at least 10–16 cm in the ground. The above ground portion of the fence should be slanted at a 30° angle outward from the base and away from the building, using supporting stakes inside the fence.

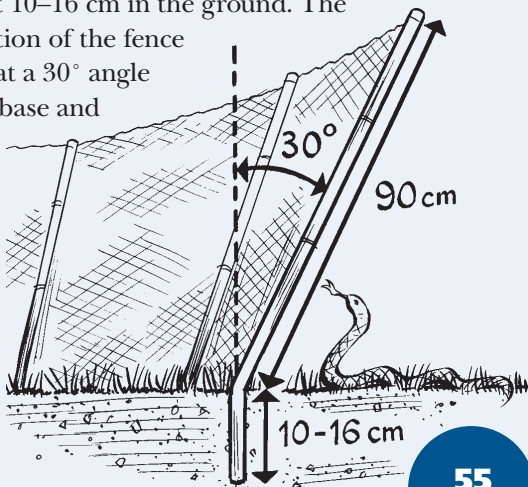

Termites/structural pests: There are two primary treatments for subterranean termites, but both are expensive and require a specialist. The first treatment involves injecting a termiticide into the soil in the ground beneath the facility. If the problem is severe, or if the first treatment is not feasible, the building must be fumigated. All stored goods must be removed from the site during fumigation. Replace wood severely damaged by structural pests.

There are alternative methods of controlling structural pests—

- Use nontoxic heat or liquid nitrogen treatments.
- Build metal barriers into the foundation of a new building. Sheets of metal protrude from between the foundation and walls of the building. The sheets are bent downward at an angle, but not touching the ground. When termites or ants attempt to climb up the foundation, they encounter the metal barrier that they cannot climb around.
- Construct sand barriers around the building as a preventative measure. However, the grains of sand must be a specific size, so this method can be expensive.

CONTROLLING TEMPERATURE

Humidity

When product labels say “protect from moisture,” store the product in a space with no more than 60% relative humidity. To reduce the effects of humidity consider—

Ventilation: Open the windows or air vents of the storeroom to allow air circulation. Ensure all windows have screens to keep out insects and birds, and either have bars or are not open wide enough for anyone to climb in. Put boxes on pallets and ensure there is space between pallets and the walls of the storeroom.

Packaging: Secure all lids. Never open a new container unless necessary.



Circulation: Use a fan to circulate fresh (outside) air. In bigger storerooms you may need a ceiling fan. Standing fans are more useful in smaller storerooms. This requires electricity and some maintenance.

Air conditioners: If possible, use an air conditioner. This is costly, depends on a constant supply of electricity, and requires regular maintenance. Depending on climatic conditions, a dehumidifier may be a less costly option. However, they also need a constant supply of electricity and require regular attention to empty the water containers.

Sunlight

Some health products are photosensitive and will be damaged if exposed to light. These include multiple vitamins, furosemide, chlorpheniramine maleate, hydrocortisone, latex products (such as male condoms), and x-ray film.

To protect products from sunlight—

- Shade the windows or use curtains, if they are in direct sunlight.
- Keep products in cartons.
- Do not store or pack products in sunlight.

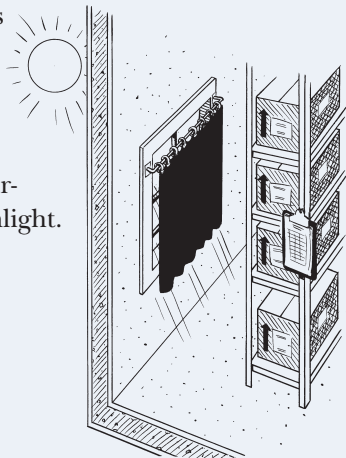

- Use opaque plastic or dark glass bottles for products that require them.
- Maintain trees on the premises around the facility to help provide shade, but check them regularly to ensure that there aren't any branches that can damage the facilities.

Heat

Remember that heat will affect many products. It melts ointments and creams and causes other products to become useless. Following the guidelines listed earlier for protecting products from humidity and sunlight will also help protect products from heat.

It is important to have thermometers in various parts of the storeroom to monitor temperature (see section on monitoring temperature). But, even if you do not have thermometers, you can still monitor the heat. If you feel hot, your products are probably hot, too.

Monitoring

Consistently monitor the temperature of the different areas within the storeroom.

- Keep thermometers in various places for monitoring.



- Keep the storeroom well ventilated (see section on humidity). For better ventilation, store boxes on pallets and leave room between rows of stacked boxes (see section on arranging products).
- Keep direct sunlight out of the storeroom.

Refrigerators and freezers

- Refrigerators that open on the top are more efficient than vertical ones, because hot air rises while cold air falls.
- The coldest part of vertical refrigerators is at the bottom.
- Store products that are sensitive to freezing or very low temperatures on the upper shelves.
- Always have enough frozen icepacks to transport items requiring cold storage in cold boxes and/or vaccine carriers. Use only icepacks filled with water. Do not use icepacks prefilled with other liquids, which are usually blue or green. When ordering cold chain equipment, larger facilities should reassess the needs for icepacks and icepack freezer space.

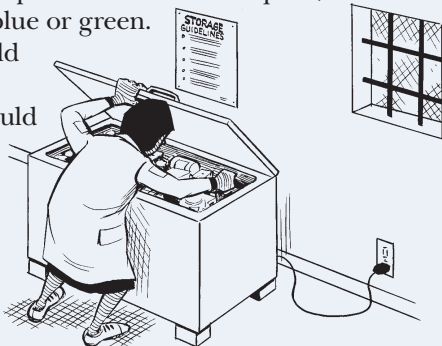

- If there is enough space, place a few plastic bottles of water in the refrigerator. This will help maintain the temperature for a longer period of time if the power is cut off.
- Place refrigerators and freezers with space between and about an arm's length away from the wall. This will increase the air circulation.
- Under ideal conditions, rooms with multiple refrigerators and/or freezers should have air conditioning. Refrigerators and freezers generate large amounts of heat, which can damage the equipment over time.
- If it is not possible to have air conditioning, install fans around the equipment to increase airflow. If installing fans, remember to place the fans so the air also flows in the spaces behind the refrigerators.
- Ideally, larger facilities should have a cold room rather than numerous refrigerators.

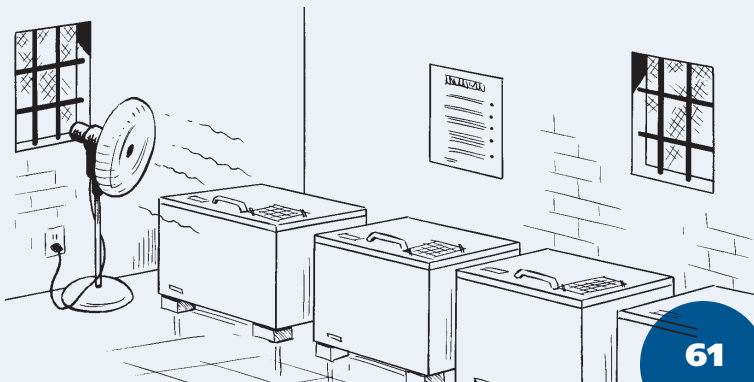

Power supply

Arrange for a solar panel generator or alternative supply of electricity for cold rooms and refrigerators if the main source of electricity is not reliable. If the generator is not solar-powered, maintain a stock of fuel sufficient to run the generator for at least a few days (see section on storing flammables). Run the generator on a regular basis (at least once a month) to ensure the system is working properly. Larger facilities may want to contract out the maintenance of the generator and electrical system.

If your electricity supply is unreliable, use kerosene or solar-powered refrigerators. Kerosene appliances require frequent maintenance. Trim the wick regularly so the flame is not too high, clean the chimney monthly, and keep a backup supply of kerosene (see section on storing flammables). Place the refrigerator away from the wall on a balanced and level surface. The appliance must be placed on a level surface or it will not function properly. Monitor the temperature regularly. The flame on a kerosene appliance should always be blue; if it is yellow, trim the wick.

Common terms

The following terms relate to temperature and medical supplies. It is important to follow the manufacturer's recommended storage conditions for all products.

Store frozen: Some products, such as certain vaccines, need to be transported within a cold chain and stored at -20°C (4°F). Frozen storage is normally for longer-term storage at higher-level facilities.

Store at 2° – 8°C (36° – 46°F): Some products are very heat sensitive but must not be frozen. These are usually kept in the first and second part of the refrigerator (never the freezer). This temperature is appropriate for storing vaccines for a short period of time.

Keep cool: Store between 8° – 15°C (45° – 59°F).

Store at room temperature: Store at 15° – 25°C (59° – 77°F).

Store at ambient temperature: Store at the surrounding temperature. This term is not widely used due to significant variation in ambient temperatures. It means “room temperature” or normal storage conditions, which means storage in a dry, clean, well ventilated area at room temperatures between 15° to 25°C (59° – 77°F) or up to 30°C , depending on climatic conditions.

Medicines with stability problems under tropical conditions:

Oral solids (tablets)

acetylsalicylic acid

amoxicillin

ampicillin

penicillin V

retinol

Oral liquids (syrups)

paracetamol

Injections/injectables

ergometrine

methylergometrine

adrenaline

reconstituted antibiotics

oxytocin¹

Source: Quick, J. S., J. R. Rankin, R. O. Laing, R. W. O'Connor, H. V. Hogerzeil, M. N. Dukes, and A. Garnett, (editors). 1997. *Managing Drug Supply*, 2nd ed. West Hartford, CT: Kumarian Press.

¹ Reynolds, J. E. F. (editor). 1996. *Martindale: The Extra Pharmacopoeia*, 31st ed. London: Royal Pharmaceutical Society.

PROTECTING AGAINST THEFT

During transport

- Verify documents.
- Ensure packing seals are used.
- Use strong boxes/containers.
- Provide reliable/well-maintained vehicles.
- Ensure drivers are reliable.
- Ensure rapid clearance at air and sea ports and through on-land borders.

At storage facilities

- Limit access to only designated staff.
- Limit the number of keys made for the facility; keep a list of people who have keys.
- Secure all locks and doors.
- Make unannounced spot checks.
- Provide independent stock count/inventory control.

In health centers

- Lock the storeroom/cupboards.
- Have inventory control cards for each product.
- Set maximum dispensing quantities.
- Have dispensers record individual prescriptions and maintain prescription or dispensing registers.
- Limit dispensing to authorized staff members only.

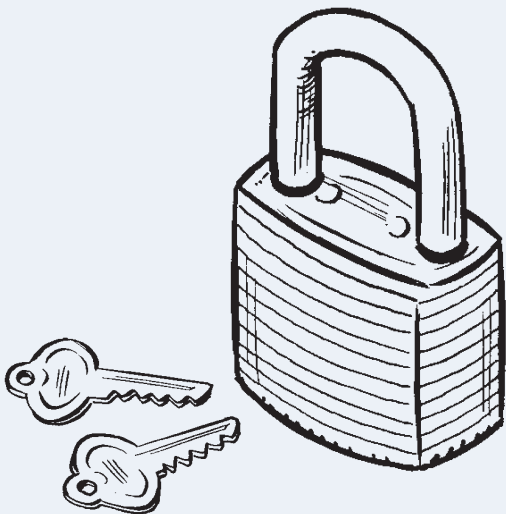

Monitor selected products

As additional protection against theft, monitor items that are fast moving, chronically in short supply, in high demand by customers, expensive, life saving, and easy to hide or disguise.

Two techniques for monitoring medicines

Select medicines likely to be stolen or misused (e.g., antibiotics, narcotics, psychotropics, antiretrovirals).

- 1.** Check inventory records for stock on hand. Then, conduct a physical inventory (physically count the quantities on hand) and compare the results.
- 2.** Check the inventory records to determine the consumption during a specified period. Then, check medical charts or prescription ledgers and count the number of treatment courses during the same period. Convert treatment courses into dose units and compare this figure with the stock issued from the storage area.

If you find a significant discrepancy, investigate further.

4. Setting Up Your Medical Store

4. Setting Up Your Medical Store

CONSTRUCTING A MEDICAL STORE

When constructing a medical store, consider the following:

Location: The store must be accessible to all the health facilities or units to be served. Ideally, a medical store should be located by itself on a separate lot to enhance security and minimize human and automobile congestion. Ensure road access for the largest vehicle that might ever need to come to the store. Do not build the store close to trees with big roots. This can kill the tree, and conversely, trees with aggressive root systems can damage the building's foundation.

Shading: Locate the store in an area where trees can be planted to provide shade and offset high temperatures.

Trees: Although it is ideal to have trees planted for shade, check the condition of any trees already on the site regularly. Cut down any weak trees so they do not fall on the building during inclement weather. Trim the other trees to avoid falling branches.

Drainage: Build the store on a raised foundation to allow rainwater to drain away from the store. If possible, locate the store in an area on higher ground.

Accessibility: Locate the store so that supplies can be easily received and distributed. This can be near an airport, or near the national road or canal system.

Security: Provide the store with adequate security from thieves, fire, etc. Fencing or perimeter walls are often used to improve security and control access.

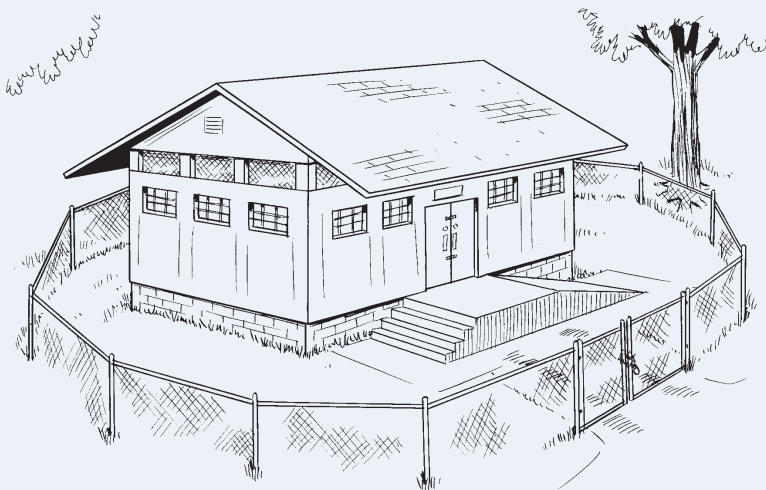

DESIGNING A MEDICAL STORE

Consider the following when designing a storage facility:

Capacity/space: Storage facilities must have the capacity for both storage and handling. Ideally, space should be evenly divided between the two. New products and packaging innovations, as well as an increase in products related to the prevention and treatment of diseases like HIV/AIDS, malaria, tuberculosis, and hepatitis B, have increased the volume of products and medical consumables that flow through warehouses. This includes items such as bed nets and insecticides for preventing malaria and more medicines to treat TB because of the increasing number of TB cases due to HIV/AIDS. When designing a new facility, do not underestimate the storage requirements.

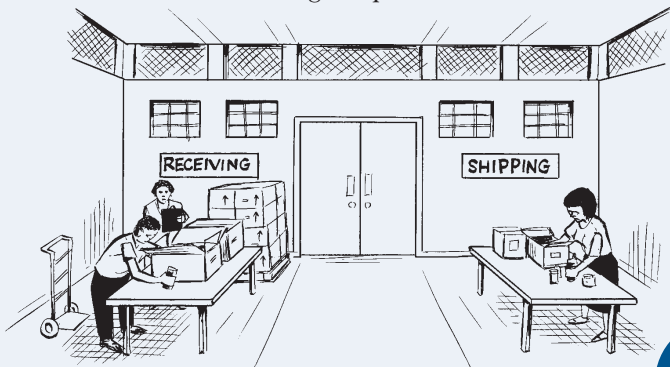

Plan the medical store with staging areas for preparing shipments (issuing) and unloading deliveries (receiving). Separate the receiving and shipping areas to avoid confusion and to enhance efficiency and security.

If a facility will be repackaging products, plan a separate clean preparation area to conduct the repackaging. Try to locate the area close to the issuing area.

Cold storage: In larger facilities it is more efficient to use cold rooms rather than numerous refrigerators or freezers (which generate heat). Ideally, larger facilities should have one room with a negative temperature for frozen products (-20°C) and another room with a positive but cold temperature (2° – 8°C) for products requiring refrigeration.

Secure storage: All medical stores should have a secure storage area for products that are likely to be stolen or abused. A locked cabinet or cupboard may be sufficient for some facilities, while other facilities may require a vault or cage.

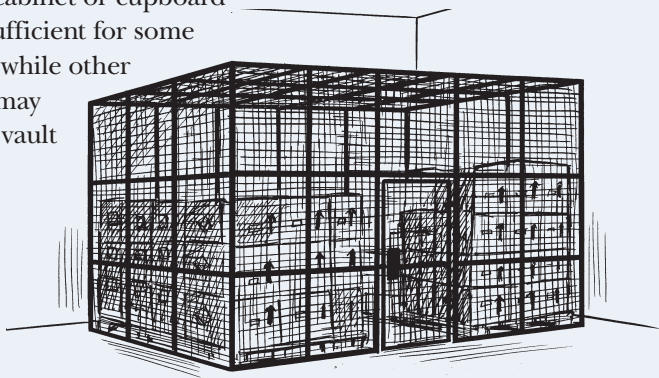

Ventilation: The location and design should ensure maximum air circulation to avoid concentrations of fumes or gases and to prevent condensation of moisture on products or walls. Use an extractor fan to remove fumes, gases, and moisture.

Roof: Design a slanting roof to allow water run-off. Extend the roof over the windows to give extra protection from rain and direct sunlight.

Ceiling: Install a double ceiling to provide insulation and ensure that supplies are kept cool.

Walls and floor: The walls and floors of a medical store should be permanent and smooth for easy cleaning. Walls preferably should be constructed of brick or concrete blocks. Perforated or bored bricks might be used for the upper portion of the wall to allow ventilation, but these should be screened to prevent the entry of rodents and other pests. Construct or treat floors of larger facilities to ensure they can withstand the frequent movement of heavy products and equipment. This should be done with the guidance of an engineer.

Doors: Plan doors wide enough to allow for the free and easy movement of supplies and handling equipment. Large facilities, such as those at the central level, often use forklifts and other handling equipment. Ensure doors are strong and reinforced to provide adequate security. Fit them with two strong locks, and install metal grills for extra protection.

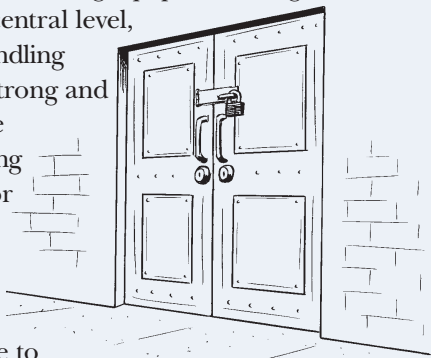

Lighting: Plan the storeroom with as much natural light (sunlight) in the day as possible to avoid the use of either florescent or incandescent bulb lighting. Florescent lighting emits ultraviolet rays, which have a negative effect on certain products. Incandescent bulbs emit heat. At the same time, take care to ensure that products are not in direct sunlight.

Windows: Plan windows that are high and wide to allow adequate ventilation. They should be high enough to not be blocked by shelves, have wire mesh to keep out insects, and be burglar proofed.

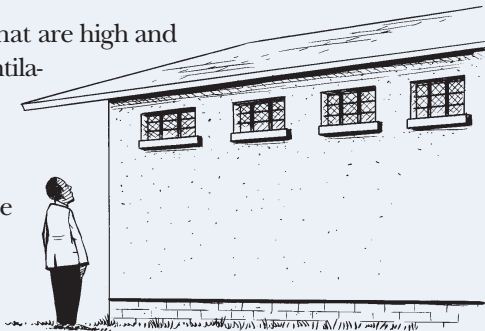

Cupboards: Provide cupboards for the storage of specific products that must be kept free from dust or light.

First aid: Keep a well stocked first aid kit to treat employees or visitors who are injured in your facility. Place the first aid kit in a central location that is easily accessible to all employees. Ensure it is clearly marked and that all employees are aware of its location and contents.



Shelves: Arrange shelves and racks in lines with a passageway not less than 90 cm wide. Avoid placing shelves only around the edge of the room, which wastes a lot of space. Place the shelves 90 cm from the walls of the storeroom to ensure they are accessible from both sides. Ideally, use adjustable shelves.

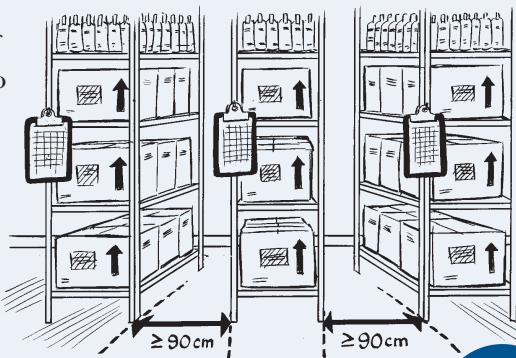

MATERIALS HANDLING EQUIPMENT AND STORAGE MEDIA

Shelves and cupboards

Use shelves and cupboards to store smaller products. Adjust the shelves as needed to allow for packages of different sizes.

Tables in the packing area

Provide large tables in the packing area for staff to use when assembling and packing shipments. Keep the tables clean.

Pallets

Pallets are used to store bulk items and larger cartons. They keep things off the floor and can be used with forklifts or dollies to move around groups of larger items. Pallets are generally used only in larger facilities because storing and moving pallets can be expensive. Smaller facilities might have a few pallets left in place to ensure air circulation and keep products off the floor.

If your facility uses pallets, remember to—

- Always inspect pallets before loading them with material. Ensure that pallets are solid and sturdy with no loose or cracked boards and no protruding nails. Damaged pallets can break while being lifted and cause serious injuries and product damage.

- Pile empty pallets neatly and out of aisles.
- If possible, keep pallets indoors, away from elements that can gradually break down the wood.

Regardless of the material they are made of, pallets increase the risk of fire because they provide open space for oxygen to fuel a fire and a large surface area for a fire to burn. Always follow the safety precautions discussed in the fire protection section of this guide.

Shelves, cupboards, tables, and pallets can be made of wood, metal, and plastic. Metal shelves, cupboards, and pallets may be steel, stainless steel, or aluminum. These tend to cost more, but are stronger, more durable, and less flammable than plastic or wood.

Also, they are not vulnerable to insect, rodent, or fungus problems.

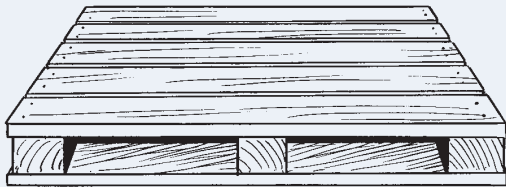
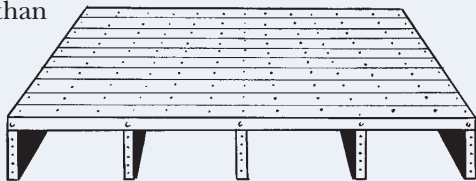

Forklifts and pallet lifters

If you plan to use forklifts or pallet lifters in your facility—

- Ensure the floor is even and able to withstand the weight of the loaded lifter.
- Ensure the lifter has room to load and unload products.
- Consider the appropriate lifter for your facility. Forklifts and pallet lifters can be powered by gas, diesel, liquid propane gas, or electricity, all of which affect the capacity and cost. Also consider the warehouse ventilation and environment.
- Keep an extra battery or a battery charger, if needed. Ensure the battery can last a full day.
- Ensure the lifter can reach the highest pallet rack.
- Keep a record of maintenance and servicing of the lifter in a secure, visible place.
- Maintain and post picture identification of employees who have been trained and are authorized to operate the lifter.

Pallet lifters come in two types, *walkie* and *seated*, and each has some advantages. Walkies are better when space is limited because the turning radius is smaller. However, they are very slow moving and are not as useful in larger warehouses. Seated lifters move much faster but are much more expensive.

5. Waste Management

5. Waste Management

CONSIDERING WASTE MANAGEMENT

Storage facility grounds, including the area around health centers, must remain free of health care waste and other garbage. Maintaining a clean environment where pharmaceuticals and other health supplies are stored will reduce the number of pests—insects and rodents—and reduce the number of people, including children, who may be injured by used medical equipment or discarded medicines.

Check with local officials about laws that pertain to health care waste management and environmental protection before instituting a disposal technique.

Plan storage, transportation, and disposal techniques that are practical and simple. Monitor disposal practices on a regular, frequent basis.

TYPES OF WASTE

Different types of waste that must be destroyed safely and effectively and their methods of disposal include—

Non-medical waste

Garden rubbish: Compost leaves, sticks, weeds, and trimmings from shrubs and trees, if feasible. Designate a separate area for composting.

Cardboard cartons: If possible, recycle cardboard; otherwise, treat like ordinary rubbish.

Ordinary rubbish: Where municipal solid waste facilities exist, dispose of ordinary rubbish in the municipal dump. Otherwise, burn or bury it.

Human waste: Use pit latrines or other toileting facilities to dispose of all human waste.

Health care waste

Sharps waste: Single-use disposable needles, needles from auto-disable syringes, scalpel blades, disposable trocars, sharp instruments requiring disposal, and sharps waste from laboratory procedures.

Other hazardous medical waste: Waste contaminated with blood, body fluids, human tissue; compounds such as mercury; pressurized containers; and wastes with high heavy metal content.

Pharmaceuticals: Expired, damaged, or otherwise unusable medicines and items contaminated by or containing medicinal substances.

DISPOSAL METHODS

Burial pits and encapsulation are suitable in locations without shallow groundwater and for small volumes of waste.

Burial pits: The bottom of the pit should be 1.5 m above the groundwater level, 3–5 m deep, and lined with a substance of low permeability, such as clay. Surround the opening with a mound to keep run-off water from entering the hole, and build a fence around the area. Periodically, cover waste layers with 10–15 cm of soil.

Encapsulation: Cement-lined pits or high-density plastic containers or drums are filled to 75% capacity with health care waste. The container is then filled with plastic foam, sand, cement, or clay to immobilize the waste. The encapsulated waste is then disposed of in a landfill or left in place if the container is constructed in the ground.

Incineration: Medium- and high-temperature incineration devices require a capital investment and an operations and maintenance budget. They operate on fuel, wood, or other combustible material and produce solid ashes and gases. Pollutants are emitted to varying degrees. The ash is toxic and must be buried in a protected pit. Combustible waste is reduced to incombustible waste with a decreased volume. The high temperatures kill microorganisms.

Medium-temperature incinerators, commonly a double-chamber design or pyrolytic incinerator, operate at a medium-temperature combustion process (800°–1,000°C).

High-temperature incinerators, recommended by WHO, treat health care waste at a temperature >1,000°C.

When operated by staff trained in correct use and maintenance, incineration in a device like this one—

- completely destroys needles and syringes
- kills microorganisms
- reduces the volume of waste
- generates less air pollution than low-temperature burning.

Note: Incinerate pharmaceuticals only if absolutely necessary.

Low-temperature burning:

Burning devices not exceeding 400°C include single-chamber brick hearths, drum burners, and burning pits. They burn incompletely and do not fully destroy waste. They may not

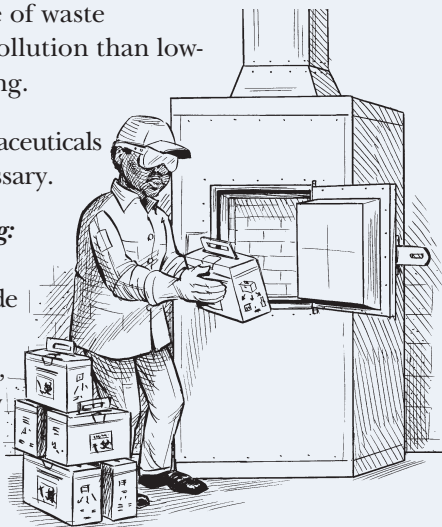

kill microorganisms. Given these shortcomings, low-temperature burning should be used only as a short-term solution.

Burn and bury: Pit burning is a low-cost but relatively ineffective means of waste disposal. A fence should surround the pit to prevent children, animals, and others from coming into contact with the waste. The pit location should avoid walking paths (high-traffic areas). The fire, usually started with a petroleum-based fuel and allowed to burn, should be supervised by designated staff and located down-wind of the facility and residential areas. The low-temperature fire emits pollutants, and the ash and remaining material should be covered with 10–15 cm of dirt.

Other methods: In addition to the common methods, other methods are used in some settings, including needle removal/needle destruction, melting syringes, steam sterilization (autoclaving and hydroclaving), and microwaving (with shredding).

Managing health care waste is a comprehensive program that requires support at all levels of the health care system. Staff involved in health care waste management must be given training and support.

Waste types not to be incinerated

- Pressurized gas containers.
- Large amounts of reactive chemical waste.
- Silver salts and photographic or radiographic wastes.
- Halogenated plastics such as polyvinyl chloride (PVC).
- Waste with high mercury or cadmium content, such as broken thermometers, used batteries, and lead-lined wooden panels.
- Sealed ampoules or ampoules containing heavy metals.

Source: Prüss, A., E. Giroult, and P. Rushbrook (editors). 1999. *Safe Management of Wastes from Health-Care Activities*. Geneva: World Health Organization.

Pharmaceutical Disposal

It is very important to dispose of pharmaceuticals properly because there can be very negative consequences to improper disposal. Improper disposal can result in—

- contaminated water supplies
- the diversion and resale of expired or inactive medicines
- improperly incinerated products, which can release toxic pollutants into the air.

Always follow your facility's procedures for handling damaged or expired medicines. In most cases, this will mean that you should send the products back to the facility that provides you with your supplies.

The disposal methods for various categories of pharmaceuticals are identified in the following table.

CATEGORY	DISPOSAL METHODS	COMMENTS
Solids	Landfill	No more than 1% of the daily municipal waste should be disposed of daily in an untreated form (non-immobilized) to a landfill.
Semi-solids	Waste encapsulation	
Powders	Waste inertization Medium and high temperature incineration (cement kiln incinerator)	
Liquids	Sewer High temperature incineration (cement kiln incinerator)	Antineoplastics not to sewer.
Ampoules	Crush ampoules and flush diluted fluid to sewer	Antineoplastics not to sewer.
Anti-infective drugs	Waste encapsulation Waste inertization Medium and high temperature incineration (cement kiln incinerator)	Liquid antibiotics may be diluted with water, left to stand for several weeks and discharged to a sewer.
Antineoplastics	Return to donor or manufacturer Waste encapsulation Waste inertization Medium and high temperature incineration (cement kiln incinerator) (chemical decomposition)	Not to landfill unless encapsulated. Not to sewer. No medium temperature incineration.

CATEGORY	DISPOSAL METHODS	COMMENTS
Controlled drugs	Waste encapsulation Waste inertization Medium and high temperature incineration (cement kiln incinerator)	Not to landfill unless encapsulated.
Aerosol canisters	Landfill Waste encapsulation	Not to be burnt: may explode.
Disinfectants	Use To sewer or fast-flowing watercourse: small quantities of diluted disinfectants (max. 50 liters per day under supervision)	No undiluted disinfectants to sewers or water courses. Maximum 50 liters per day diluted to sewer or fast-flowing watercourse. No disinfectants at all to slow moving or stagnant watercourses.
PVC plastic, glass	Landfill	Not for burning in open containers.
Paper, cardboard	Recycle, burn, landfill	

Source: World Health Organization (WHO). 1999. *Guidelines for Safe Disposal of Unwanted Pharmaceuticals In and After Emergencies*. Geneva: WHO. Available at <http://www.who.int/medicines/library/par/who-edm-par-99-2/who-edm-par-99-2.htm>

Particular attention must be given to disposal of the following categories of pharmaceuticals—

- controlled substances, such as narcotics and psychotropic medicines
- anti-infective drugs
- antineoplastics
- cytotoxic anti-cancer drugs, toxic drugs
- antiseptics and disinfectants.

Safety boxes

Safety boxes or sharps containers are puncture- and water-resistant, impermeable containers. When used correctly, they reduce the risk of skin-puncture injuries that may spread disease.

- Do not recap syringes before disposal.
- Place the syringe and needle in the sharps box **immediately** after use.
- Keep the sharps box where the injections are given.
- Do not overfill the sharps containers (about $\frac{3}{4}$ full).
- When $\frac{3}{4}$ full, close box tab completely to cover the opening and tape it shut.
- Store the box in a safe and secure location until ready for final disposal.
- Do not empty and refill sharps boxes. Fill once and discard immediately.

See annex 2 for more information about waste disposal.

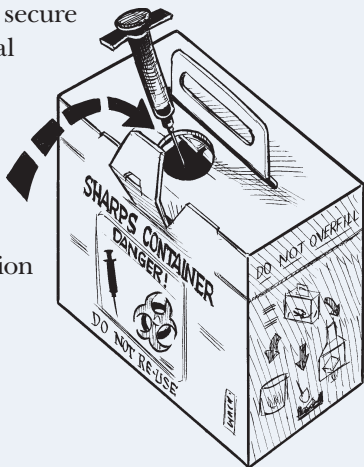

6. Bibliography

6. Bibliography

BIBLIOGRAPHY

Appropriate Health Resources and Technologies Action Group (AHRTAG). 1994. *How to Manage a Health Centre Store: Updated second edition*. London: AHRTAG.

Family Planning Logistics Management (FPLM). 1994. *Pest Management for Warehouses Storing Contraceptive Products in Developing Countries*. Arlington, Va.: John Snow Inc./FPLM.

Prüss, A., E. Giroult, and P. Rushbrook (editors). 1999. *Safe Management of Wastes from Health-Care Activities*. Geneva: World Health Organization.

Quick, J.D., J. R. Rankin, R. O. Laing, R. W. O'Connor, H. V. Hogerzeil, M. N. Dukes, and A. Garnett (editors). 1997. *Managing Drug Supply, 2nd ed.* West Hartford, CT: Kumarian Press.

Texas Wildlife Management Service. 1999. *Wildlife Damage Management: Snakes and Their Control*. San Antonio, Tx.: Texas Wildlife Management Service.

World Health Organization (WHO). 1999. *Guidelines for Safe Disposal of Unwanted Pharmaceuticals In and After Emergencies*. Geneva: WHO.

World Health Organization (WHO) and International Federation of Pharmaceutical Manufacturers Associations. 1991. *Guidelines on the Storage of Essential Drugs in Eastern and Southern Africa: A Manual for Storekeepers*. Geneva: WHO.

7. Annexes

7. Annexes

ANNEX 1: RESOURCES

General Warehouse Equipment

UNICEF Supply Division offers material handling equipment, steel cupboards, prefabricated warehouses, and packing machinery.

Phone +453-527-3527 Fax: +453-526-9421

Email: supply@unicef.org or customer@unicef.org

<http://www.unicef.org/supply/>

MaterialHandlingInfo.com contains helpful information for warehouses and larger facilities, including an online worksheet designed to help you select an appropriate storage medium for a specific type of inventory.

<http://www.mhinfo.com/mhi/>

The Warehouse Rack Company distributes new and used warehouse equipment, including various types of racks, shelving, pallets, forklift, etc. (U.S. based).

Phone: +1 832-467-2221 Fax: +1 832-467-2223

<http://www.warehouse rack.com/>

Gross & Associates are independent consultants that specialize in material handling logistics. Their website contains free literature and tips about warehousing and distribution and a newsletter.

<http://www.grossassociates.com>

Note: Recommendations are made by John Snow, Inc./DELIVER.

Pallets and Pallet Racks

Advance Storage supplies pallet racks and other storage systems for larger warehouses (U.S. based).

Phone: +1 714-902-9000 Fax: +1 714-902-9001

<http://www.advancestorage.com>

The National Wooden Pallet & Container Association (U.S. based).

Phone: +1 703-519-6104 Fax: +1 703-519-4720

<http://www.nwpc.com>

Pallet-Mall lists international suppliers of pallets and has information and definitions pertaining to pallets (U.S. based).

Phone: +1 603-357-0484 Fax: +1 603-357-9379

<http://www.pallet-mall.com>

Forklifts

Yale Materials Handling Corporation is a global company that produces lift trucks and replacement parts.

<http://www.yale.com>

Forklift Operation and Safety. Instructional Designs, Inc. An online operator training course, one of several Occupational Safety and Health Administration (OSHA) training topics provided free from Instructional Designs, Inc.

<http://www.free-training.com/osha/forklift/forkmenu.htm>

Refrigerators and Cold Chain Equipment

WHO. Vaccines and Biologicals catalogue 2003 lists documents, training modules, and communications materials produced and distributed by the WHO's Department of Vaccines and Biologicals, including materials about cold chain logistics systems and training materials on the maintenance and repair of equipment.

<http://www.who.int/vaccines-documents/catalogue.pdf>

The Sustainable Village is one resource for energy-saving appliances (U.S. based).

Phone: +1303-998-1323 Fax: +1 -303-449-1348

<http://www.thesustainablevillage.com>

Fire Fighting Equipment

Chubb Fire manufacturers distributes and services portable fire fighting equipment in Africa (based in South Africa).

Phone: +27-11-653-0451 (exports) +27-11-653-0439 (sales)

Fax: +27-11-314-3571 (sales)

<http://www.chubb.co.za/CFS/main.htm>

ANNEX 2: SUGGESTED READING

Most of the documents listed below are published by the World Health Organization. World Wide Web links are provided, but if you do not have access to the Internet, information on how to obtain the WHO documents is available from—

World Health Organization
EDM Documentation Center
CH-1211 Geneva 27
Switzerland
Tel: +41-22-791-211 Fax: +41-22-791-4167

General

Guide to Good Storage Practices for Pharmaceuticals.
(Annex 9 to the Thirty-seventh Report of the WHO Expert Committee on Specifications for Pharmaceutical Preparations). WHO. 2001.
http://www.who.int/medicines/library/qsm/good_storage.pdf

Model List of Essential Medicines (13th list).
WHO. April 2003.
<http://www.who.int/medicines/organization/par/edl/expertcomm.shtml>

Quick, J.D., J. R. Rankin, R. O. Laing, R. W. O'Connor, H. V. Hogerzeil, M. N. Dukes, and A. Garnett (editors). 1997. *Managing Drug Supply*, 2nd ed. West Hartford, CT: Kumarian Press.

Interagency Guidelines: Operational Principles for Good Pharmaceutical Procurement.

WHO/EDM/PAR/99.5. WHO. 2000.

<http://www.who.int/medicines/library/par/who-edm-par-99-5/who-edm-par-99-5.htm>

Model Guidelines for the International Provision of Controlled Medicines for Emergency Medical Care.

WHO/PSA/96.16. WHO. 1996.

<http://www.who.int/medicines/library/qsm/who-psa-96-17/who-psa-96-17en.htm>

Interagency Guidelines: Guidelines for Drug Donations, revised 1999.

WHO/EDM/PAR/99.4. WHO. 1999.

<http://www.who.int/medicines/library/par/who-edm-par-99-4/who-edm-par-99-4.htm>

Unhelpful Donations.

(WHO reporting form).

http://www.who.int/medicines/library/docseng_from_a_to_z.shtml#s

How to Estimate Warehouse Space for Drugs.

WHO/DAP/93.3. WHO. 1993.

<http://www.who.int/medicines/library/dap/who-dap-93-3/who-dap-93-3.htm>

Achieving Balance in National Opioids Control Policy– Guidelines for Assessment.

WHO/EDM/QSM/2000.4. WHO. 2000.

<http://www.who.int/medicines/library/qsm/who-edm-qsm-2000-4/who-edm-qsm-2000-4.htm>

AHRTAG. 1994. *How to Manage a Health Centre Store: Updated second edition*. London: Appropriate Health Resources and Technologies Action Group.

Temperature and Stability

Stability of Essential Medicines in Tropical Climates: Zimbabwe. WHO/DAP/94.16. WHO. 1996.

<http://www.who.int/medicines/library/dap/who-dap-94-16/who-dap-94-16.htm>

Stability of Oral Oxytocics in Tropical Climates.

WHO/DAP/94.13. WHO. 1995.

<http://www.who.int/medicines/library/dap/who-dap/94-13/who-dap-94-13.htm>

Stability of Injectable Oxytocics in Tropical Climates.

WHO/DAP/93.6. WHO. 1993.

<http://www.who.int/medicines/library/dap/who-dap-93-6.htm>

Nonproprietary Names for Pharmaceuticals

General Principles for Guidance in Devising International Nonproprietary Names for Pharmaceutical Substances.

WHO. 2001.

<http://www.who.int/medicines/organization/qsm/activities/qualityassurance/inn/inngen.html>

International Nonproprietary Names.

<http://www.who.int/medicines/organization/qsm/activities/qualityassurance/inn/orginn.shtml>

International Nonproprietary Names (INN) for Pharmaceutical Substances: Names for Radicals & Groups Comprehensive List.

WHO/EDM/QSM/2003.1

<http://www.who.int/medicines/library/qsm/radicaldoc2002.pdf>

Product Information Sheets, 2000 edition. WHO Department of Vaccines and Biologicals. (Contains information on refrigerators, freezers, thermometers, cold rooms, and waste management.)

<http://www.who.int/vaccines-documents/DocsPDF00/www518.pdf>

Guideline for Establishing or Improving Primary and Intermediate Vaccine Stores.

<http://www.who.int/vaccines-documents/DocsPDF02/www715.pdf>

Waste Management

Safe Management of Wastes from Health-Care Activities.

WHO. 1999.

http://www.who.int/injection_safety/toolbox/docs/en/waste_management.pdf

WHO Aide-Memoire: Safe Health-Care Waste Management.

WHO. September 2000.

http://www.who.int/bct/Main_areas_of_work/SIGN/pdf_documents/hcwaste.pdf

Health-Care Waste Management: At a Glance.

WHO. June 2003.

<http://www.healthcarewaste.org/linked/onlinedocs/WW08383.pdf>

“First, Do No Harm.” Introducing Auto-disable Syringes and Ensuring Injection Safety in Immunization Systems of Developing Countries.

WHO/V&B/02.26. WHO. 2002.

<http://www.who.int/vaccines-documents/DocsPDF02/www704.pdf>

Interagency Guidelines: Guidelines for Safe Disposal of Unwanted Pharmaceuticals In and After Emergencies.

WHO/EDM/PAR/99.2. WHO. 1999.

<http://www.who.int/medicines/library/par/who-edm-par-99-2/who-edm-par-99-2.htm>

ANNEX 3: SAMPLE FORMS

Inventory Control Card (stockkeeping record)

INVENTORY CONTROL CARD						
Commodity Number			Description			
Unit		Maximum Stock		Minimum Stock		Location
Date	Transaction Reference	Quantity Received	Quantity Issued	Losses/ Adjustments	Quantity on Hand	Quantity on Order

Requisition and Issue Voucher (transaction record)

REQUISITION AND ISSUE VOUCHER					
Requisition and Issue Voucher No.: _____					
Date: _____		Ship to: _____			

REQUISITION			ISSUE		Remarks
Article	Quantity on Hand	Quantity Requested	Shipped	Received	
<p>REQUISITION Requested by: _____ Date: _____</p> <p>Approved by: _____ Date: _____</p>					
<p>ISSUE: Approved by: _____ Date: _____</p> <p>Shipped by: _____ Date: _____</p>					
<p>RECEIPT: Received by: _____ Date: _____</p>					

(make 4 copies)

Quarterly Report & Request Form (consumption record)

QUARTERLY REPORT & REQUEST FORM

Province: _____ District _____ Location: _____

Facility type: Depot: _____ District Store: _____ SDP/Clinic: _____ Other: _____

Report for Quarter Beginning: _____, 20____ Ending _____, 20____

Product	Beginning Balance	Received This Quarter	Dispensed/ Issued	Losses/ Adjustments	Ending Balance	Quantity Needed

Submitted: _____ Date: _____

Explanation of losses: _____

ANNEX 4: MEDICINE NAMES

Remember that four different types of names are used to describe medicines:

Chemical names: These are usually complicated and difficult to use in identifying medicines.

International nonproprietary name: An International Nonproprietary Name (INN) identifies a pharmaceutical substance or active pharmaceutical ingredient by a unique name that is globally recognized and is public property. A nonproprietary name is also known as a generic name.

Brand name: These are also known as the branded, proprietary, commercial, or trade name. Manufacturers develop these names for marketing purposes.

National nonproprietary name: Similar to INNs but can vary from country to country. These are used predominantly in the U.S.

ANNEX 5: CONVERSION FACTORS

Temperature

From Celsius to Fahrenheit: $(C \times 1.8) + 32 = F$

From Fahrenheit to Celsius: $(F - 32) \div 1.8 = C$

Length

From inches to centimeters: multiply by 02.54

From feet to centimeters: multiply by 30.48

From feet to meters: multiply by 00.3048

From yards to meters: multiply by 00.91

From millimeters to inches: multiply by 00.04

From centimeters to inches: multiply by 00.39

From centimeters to feet: multiply by 00.03

From meters to yards: multiply by 01.09

Area

From sq. inches to sq. centimeters: multiply by 06.5

From sq. feet to sq. meters: multiply by 00.09

From sq. yards to sq. meters: multiply by 00.8

From sq. centimeters to sq. inches:	multiply by 00.1550
From sq. meters to sq. feet:	multiply by 10.76
From sq. meters to sq. yards:	multiply by 01.196

Volume

From cubic inches to cubic cm:	multiply by 16.39
From cubic inches to liters:	multiply by 00.01639
From cubic feet to liters:	multiply by 28.32
From cubic feet to cubic meters:	multiply by 00.03
From cubic centimeters to liters:	divide by 01.000
From cubic cm to cubic inches:	divide by 00.06102
From cubic meters to cubic feet:	multiply by 35.31
From liters to U.S. gallons:	multiply by 00.26
From liters to U.S. pints:	multiply by 02.11

Weight

From ounces to grams:	multiply by 28.35
From pounds to kilograms:	multiply by 00.45
From grams to ounces:	multiply by 00.035
From kilograms to pounds:	multiply by 02.20

JOHN SNOW, INC.

DELIVER

1616 N. FORT MYER DRIVE, 11TH FLOOR

ARLINGTON, VA 22209 USA

TEL: 703-528-7474

FAX: 703-528-7480

deliver.jsi.com

USAID INFORMATION CENTER

RONALD REAGAN BUILDING

WASHINGTON, D.C. 20523-1000 USA

TEL: 202-712-4810

FAX: 202-216-3524

www.usaid.gov

WORLD HEALTH ORGANIZATION

DEPARTMENT OF ESSENTIAL DRUGS AND MEDICINES POLICY (EDM)

CH-1211 GENEVA 27

SWITZERLAND

TEL: + 41 22 791 21 11

<http://www.who.int/medicines>